

User's Guide

Opal™ 690Q/670/650



This household sewing machine is designed to comply with IEC/EN 60335-2-28 and UL1594.

IMPORTANT SAFETY INSTRUCTIONS

When using an electrical appliance, basic safety precautions should always be followed, including the following:

Read all instructions before using this household sewing machine. Keep the instructions at a suitable place close to the machine. Make sure to hand them over if the machine is given to a third party.

DANGER – To reduce the risk of electric shock:

- A sewing machine should never be left unattended when plugged in. Always unplug this sewing machine from the electric outlet immediately after using and before cleaning, removing covers, lubricating or when making any other user servicing adjustments mentioned in the instruction manual.

WARNING – To reduce the risk of burns, fire, electric shock, or injury to person:

- Do not allow to be used as a toy. Close attention is necessary when this sewing machine is used by or near children.
- Use this sewing machine only for its intended use as described in this manual. Use only attachments recommended by the manufacturer as contained in this manual.
- Never operate this sewing machine if it has a damaged cord or plug, if it is not working properly, if it has been dropped or damaged, or dropped into water. Return the sewing machine to the nearest authorized dealer or service center for examination, repair, electrical or mechanical adjustment.
- Never operate the sewing machine with any air openings blocked. Keep ventilation openings of the sewing machine and foot control free from the accumulation of lint, dust, and loose cloth.
- Keep fingers away from all moving parts. Special care is required around the sewing machine needle.
- Always use the proper needle plate. The wrong plate can cause the needle to break.
- Do not use bent needles.
- Do not pull or push fabric while stitching. It may deflect the needle causing it to break.
- Wear safety glasses.
- Switch the sewing machine off (“0”) when making any adjustment in the needle area, such as threading needle, changing needle, threading bobbin, or changing presser foot, etc.
- Never drop or insert any object into any opening.
- Do not use outdoors.
- Do not operate where aerosol (spray) products are being used or where oxygen is being administered.
- To disconnect, turn all controls to the off (“0”) position, then remove plug from outlet.
- Do not unplug by pulling on cord. To unplug, grasp the plug, not the cord.

- The foot control is used to operate the machine. Avoid placing other objects on the foot control.
- Do not use the machine if it is wet.
- If the LED lamp is damaged or broken, it must be replaced by the manufacturer or its service agent or a similarly qualified person, in order to avoid a hazard.
- If the supply cord connected with the foot control is damaged, it must be replaced by the manufacturer or its service agent or a similarly qualified person, in order to avoid a hazard.
- This sewing machine is provided with double insulation. Use only identical replacement parts. See instructions for Servicing of Double-Insulated Appliances.

SAVE THESE INSTRUCTIONS

For Europe only:

This appliance can be used by children aged from 8 years and above and persons with reduced physical, sensory or mental capabilities or lack of experience and knowledge if they have been given supervision or instruction concerning use of the appliance in a safe way and understand the hazards involved. Children shall not play with the appliance. Cleaning and user maintenance shall not be made by children without supervision.

The noise level under normal operating conditions is less than 75dB(A).

The machine must only be used with foot control of type FR2 manufactured by Shanghai Binao Precision Mould Co., Ltd.

For outside Europe:

This sewing machine is not intended for use by persons (including children) with reduced physical, sensory or mental capabilities, or lack of experience and knowledge, unless they have been given supervision or instruction concerning use of the sewing machine by a person responsible for their safety. Children should be supervised to ensure that they do not play with the sewing machine.

The noise level under normal operating conditions is less than 75dB(A).

The machine must only be used with foot control of type FR2 manufactured by Shanghai Binao Precision Mould Co., Ltd..

SERVICING OF DOUBLE INSULATED PRODUCTS

In a double-insulated product, two systems of insulation are provided instead of grounding. No ground means is provided on a double-insulated product, nor should a means for grounding be added to the product. Servicing of a double-insulated product requires extreme care and knowledge of the system and should be done only by qualified service personnel. Replacement parts for a double-insulated product must be identical to those parts in the product. A double-insulated product is marked with the words 'DOUBLE INSULATION' or 'DOUBLE INSULATED'.



CONTENTS

Machine overview	4
Included accessories	5
Stitch table – Utility Stitches	7
Stitch Overview.....	9
Fonts	10
Getting Ready to Sew	11
Unpacking	12
Packing away after sewing.....	12
Accessory Tray	12
Using the free arm	12
Connecting the foot control cord	13
Connect the power cord and foot control	13
Lower the feed teeth.....	14
Presser Foot Pressure (650/670).....	14
Raise and lower the presser foot (650/670).....	14
Raise and lower the presser foot (690Q).....	14
Changing the presser foot	14
Changing the Needle.....	15
Needles	15
Spool pins and spool caps	16
Threading the upper thread.....	17
Needle threader.....	18
Cutting the thread.....	18
Threading for twin needle	19
Winding the bobbin with the machine threaded	20
Winding the bobbin using the vertical spool pin	20
Winding the bobbin using the auxiliary spool pin	21
Inserting the bobbin.....	21
Thread tension (650)	21
Automatic thread tension (670/690Q).....	21
Correct and Incorrect Thread Tension	22
EXCLUSIVE SENSOR SYSTEM™ (ESS) (690Q).....	22
Sensor Foot Pressure (P-foot pressure).....	22
Sensor Foot Lift	22
Starting to sew	22
Operating Your Opal™ 650 sewing machine	23
Function panel (650)	24
Functions On The Touch Panel	25
Sewing Mode (650)	26
Selecting a stitch	28
Selecting a font	28
Programming (650).....	29
My Stitches Menu	31
SET Menu	32
Operating Your Opal™ 670/690Q sewing machine	33
Functions Panel (670/690Q)	34
Functions on the TouchScreen.....	35
Sewing Mode (670/690Q).....	36
Selecting a stitch.....	37
Selecting a font	37
Programming (670/690Q)	38
My Stitches Menu	40
SET Menu	41
Sewing	43
Exclusive SEWING ADVISOR™	44
Seam	45
Overcast.....	45
Seam and overcast.....	46
Baste.....	46
Blind hem.....	46
Hem	47
Sewing buttonholes	48
Sewing on buttons	50
Sewing zippers.....	51
Center Zipper	51
Darning and mending	51
Bartack (manual)	52
Decorative Tapering Stitches (690Q).....	52
Quilting.....	53
Speciality Stitches.....	54
Pop-up messages	55
Pop-up messages.....	56
Taking care of your machine	59
Cleaning the machine	60
Troubleshooting.....	61

Note: The OPAL sewing machine models will be referred to as simply 690Q, 670 and 650 in this User's Guide.

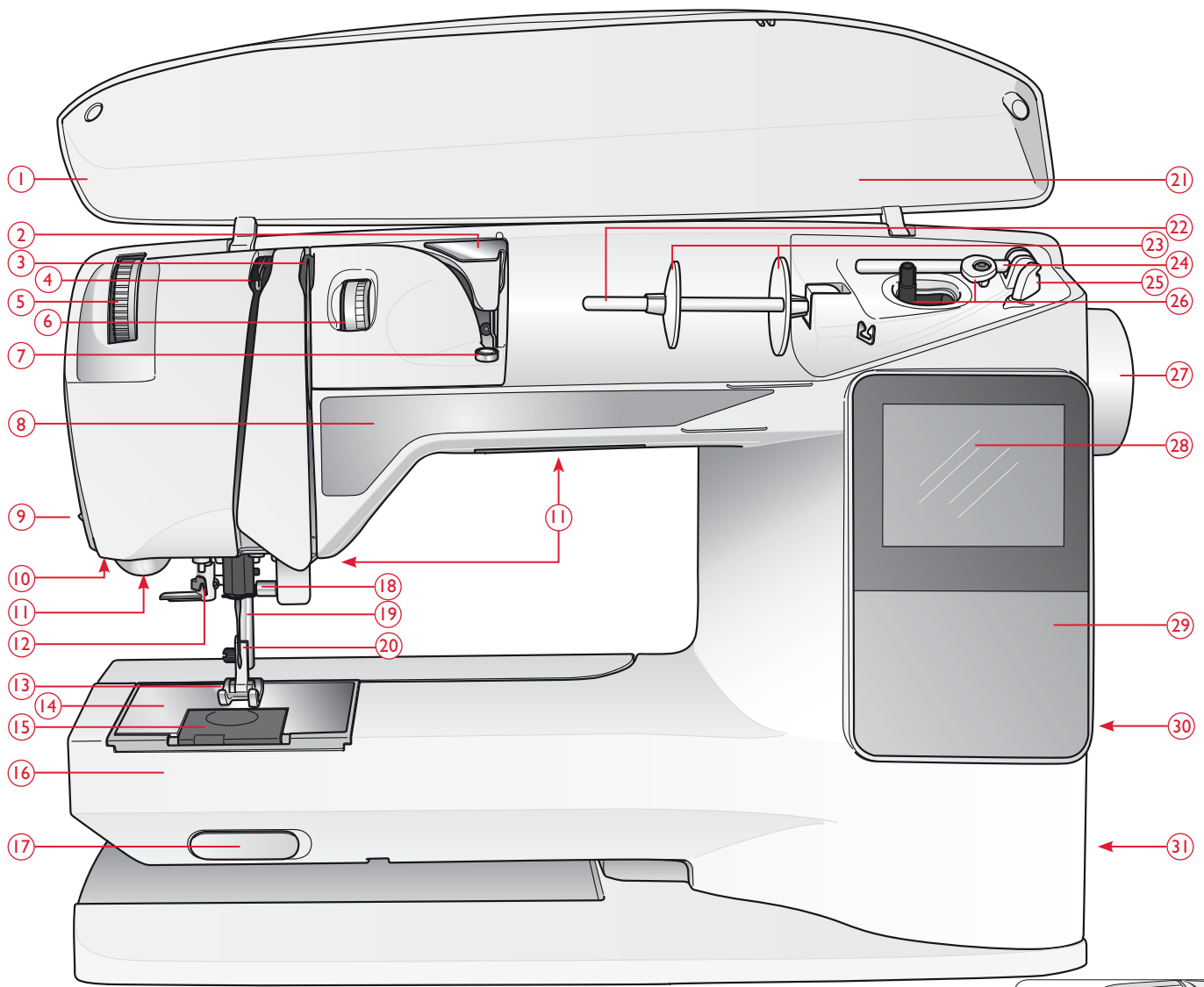

MACHINE OVERVIEW

- | | | |
|--|--|--|
| 1. Lid | 14. Stitch plate | |
| 2. Pre-tension thread guide | 15. Bobbin cover | |
| 3. Thread tension disks | 16. Free arm | |
| 4. Thread take-up lever | 17. Drop feed teeth switch | |
| 5. Presser foot pressure dial (650/670) | 18. Needle bar with needle clamp screw | |
| 6. Thread tension dial (650) | 19. Presser bar | |
| 7. Thread tension for bobbin winding | 20. Presser foot ankle | |
| 8. Function Panel | 21. Stitch overview | 28. Graphic Display (650)/
TouchScreen (670/690Q) |
| 9. Thread cutter | 22. Spool pin | 29. Function Panel (650) |
| 10. Sensor One-Step Buttonhole Foot socket | 23. Spool caps | 30. Stylus holder |
| 11. LED-lights | 24. Auxiliary spool pin | 31. ON/OFF switch, connectors for
power cord and foot control |
| 12. Needle threader | 25. Thread cutter for bobbin thread | 32. Handle |
| 13. Presser foot | 26. Bobbin spindle, Bobbin stop | 33. Presser foot lever (650/670) |
| | 27. Handwheel | |

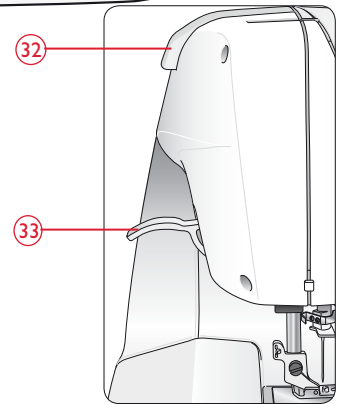

INCLUDED ACCESSORIES

Presser Feet



Utility Foot A

Attached on the machine upon delivery. This foot is used mainly for straight stitching and zigzag stitching with a stitch length longer than 1.0.



Utility Foot B

When sewing decorative stitches or short zigzag stitches and other utility stitches with less than 1.0 mm stitch length, use this foot. The tunnel on the underside of the foot is designed to feed smoothly over the stitches.



Buttonhole Foot C

This foot is used for sewing buttonholes step by step. Use the guide lines on the toe of the foot to position the garment edge. The two tunnels on the bottom of the foot ensures a smooth feed over the buttonhole columns. The finger on the back of the foot holds cording for corded buttonhole.



Blind Hem Foot D

This foot is used for blind hem stitches. The inner edge of this foot guides the fabric. The right toe of the foot is designed to ride along the hem edge.



Zipper Foot E

This foot can be snapped on either to the right or to the left of the needle, making it easy to sew close to both sides of the zipper teeth. Move needle position to right or left to sew closer to zipper teeth or for covering large cording.



Edging Foot J

This foot is used for overcasting and seam/overcasting. Stitches form over the pin which prevents puckering at the edge of the fabric.

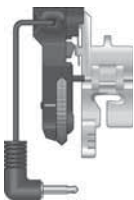

Sensor One-Step Buttonhole Foot

When connected to the machine, the buttonhole is sewn in a suitable length to the button size that has been entered into the machine.



Glide Sole

If sewing on foam, vinyl, plastic, or leather, the material might stick to the foot and prevent the sewing machine from feeding properly. When using any of the above materials, sew on a piece of scrap fabric, to make sure the machine feeds smoothly. If not, fasten the self-adhesive glide soles to the underside of the presser foot.

Additional Presserfeet for 690Q

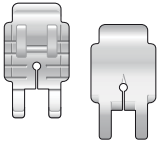

Quilter's 1/4" Piecing foot P

This foot is used when piecing quilt blocks. Red lines mark 1/4" (6mm) and 1/8" (3mm) pivot points in front of and behind the needle.



Clear Open Toe Foot

For satin stitch applique, taper stitches and decorative stitches. The tunnel on the underside of the foot feeds smoothly over the stitches and the transparent foot with open front gives greater visibility for accuracy.

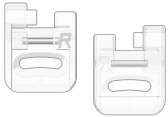

Embroidery/Darning Foot R

This foot is used for free motion embroidery/quilting/stitching.

1. Seam ripper
2. Brush
3. Screwdriver
4. Felt pad (2)
5. Multipurpose tool/Button reed (690Q, optional with 650/670, part number 4131056-01)
6. Bobbins (5)
7. Stylus (670/690Q)
8. Edge/Quilting guide (690Q, optional with 650/670, part number 4126019-45)
9. Spool cap, large
(attached on the machine at delivery)
10. Spool cap, medium
(attached on the machine at delivery)
11. Spool cap, small

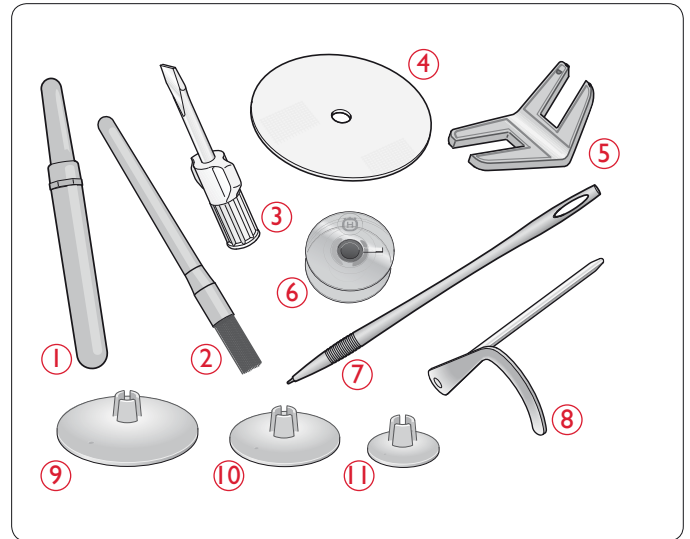

Accessories not pictured

Threads



















Hard cover

















Foot control, cable, net cable

Warranty card

Needles

STITCH TABLE – UTILITY STITCHES

Stitch	Stitch No.		Stitch Name	Presser Foot	Application
	670/ 690Q	650			
	1	1	Straight Stitch, center needle position	A/B	For all types of sewing. Select 29 different needle positions.
	2	2	Stretch Stitch, left needle position	A/B	For seams in tricot and stretch fabric.
	3	3	Reinforced Straight Stitch, center needle position	A/B	For seams which are subject to considerable strain. Triple and elastic for reinforced seams. Use to reinforce and topstitch sportswear and working clothes. For topstitch, increase the stitch length.
	4	–	Straight Stitch with FIX	A/B	Begins and ends with forward and reverse sewing.
	5	4	Zigzag	A/B	For appliqué work, lace edging, sewing on bands etc. Stitch width increases equally to the left and right.
	6	5	Three-Step Zigzag	A/B	For mending, sewing on patches and elastics. Suitable for light and medium weight fabric.
	7	6	Two-Step Zigzag	A/B	For joining two pieces of fabric with finished edges and for elastic shirring.
	8	7	Reinforced Zigzag	B	For joining fabric edge to edge or overlapping in leather. For decorative sewing.
	9	8	Baste Stitch	A/B	For joining two pieces of fabric with a long stitch length (reduce thread tension according to recommendations on the GraphicDisplay (650)).
	10	–	Straight Basting Stitch	A	Use together with the foot control to baste layers of the fabric together. Lower the feed teeth. Sew a stitch, raise the presser foot and move the fabric. Lower the presser foot and make the next stitch. Repeat until the basting is done.
	11	9	Overcast Stitch	J	Seam and overcast in one step along the edge or trim later. For light stretch and non-stretch fabrics.
	12	10	Stretch Seam Overcast Stitch	B	Seam and overcast in one step along the edge or trim later. For medium and medium/heavy stretch fabrics.
	13	11	Double Overlock Stitch	B	Seam and overcast in one step along the edge or trim later. For heavy stretch and heavy woven fabrics.
	14	12	Overlock Stitch	B	Seam and overcast in one step along the edge or trim later. For medium stretch fabrics.
	15	13	Elastic/Casing Stitch	B	For overlapped seams in tricot. To sew casing over narrow elastic.
	16	14	Elastic Stitch or Smocking	A/B	Sew over two rows of elastic thread for elastic shirring.
	17	15	Flatlock Stitch	B	Decorative hems and overlapped seams, belts and bands. For medium/heavy stretch fabrics.
	18	16	Stretch Blind Hem Stitch	D	Blind hems in medium and heavy stretch fabrics.
	19	17	Woven Blind Hem	D	Blind hems in medium and heavy woven fabrics.

Stitch	Stitch No.		Stitch Name	Presser Foot	Application
	670/ 690Q	650			
	20	18	Bridging Stitch	A/B	For joining two pieces of fabric with finished edges and for elastic shirring.
	21	–	Darning Stitch (side to side)	A	For mending small tears.
	22	19	Darning Stitch (forward and backward)	A/B	Darn and mend small holes in work clothes, jeans, tablecloths and more. Stitch over the hole, press reverse for continuous darning and auto stop.
	23	20	Bartack (manual)	A/B	Reinforce pockets, shirt openings, belt loops as well as at lower end of a zipper.
	24	–	Belt Loop Stitch	A	For securing belt loops.
	25	21	Bartack Buttonhole	Sensor One-Step Buttonhole Foot/C	Standard buttonhole for most fabric weights.
	26	22	Round End Buttonhole	Sensor One-Step Buttonhole Foot/C	For blouses and children's garments.
	27	23	Medium Reinforced Buttonhole	C	For medium and heavy fabrics.
	28	24	Heirloom Buttonhole	Sensor One-Step Buttonhole Foot/C	For “hand look” on fine and delicate fabrics. <i>Tip: For jeans buttonholes, increase length and width of the buttonhole. Use thicker thread.</i>
	29	25	Keyhole Buttonhole	Sensor One-Step Buttonhole Foot/C	For tailored jackets, coats, etc.
	30	26	Heavy Duty Buttonhole	Sensor One-Step Buttonhole Foot/C	With reinforced bartacks.
	31	27	Leather Straight Stitch Buttonhole	A/B	For leather and suede.
	32	28	Eyelet	B	For belts, laces, etc.
	33	29	Automatic Button Sewing	No presser foot	For sewing on buttons. Set the number of stitches on the GraphicDisplay/ TouchScreen.
	34	30	Satin stitch, narrow	B	For appliqués, sewing on laces and trims. For light and medium fabrics.
	35	31	Satin stitch, medium	B	For appliqués, sewing on laces and trims. For light and medium fabrics.
	36	32	Satin stitch, wide	B	For appliqués, sewing on laces and trims. For heavy fabrics.

STITCH OVERVIEW

The stitches marked with a red box can be used for tapering. The same stitches are shown in the lid colored in blue (690Q).

Stitch overview for 690Q, showing 52 rows of various stitch patterns. Red boxes highlight specific stitches used for tapering.

1 2 3 4

W 690Q

Stitch overview for 670, showing 50 rows of various stitch patterns.

1 2 3 4

W 670

Stitch overview for 650, showing 40 rows of various stitch patterns.

1 2 3 4

W 650

FONTS

Block

A B C D E F G H I J K L M N O P Q
a b c d e f g h i j k l m n o p q
1 2 3 4 5 6 7 8 9 0 Æ æ Ø ø à

R S T U Ü V W X Y Z Å Ä Ö - . _
r s t u ü v w x y z å ä ö @ . . _
á ç ë è é ê í ó ù ú Ñ ñ ß & ? ! ' . _

Brush Line (670/690Q)

A B C D E F G H I J K L M N O P Q
a b c d e f g h i j k l m n o p q
1 2 3 4 5 6 7 8 9 0 Æ æ Ø ø à

R S T U Ü V W X Y Z Å Ä Ö - . _
r s t u ü v w x y z å ä ö @ . . _
á ç ë è é ê í ó ù ú Ñ ñ ß & ? ! ' . _

Cyrillic and Hiragana

Russian and Japanese fonts. See the fonts on the GraphicDisplay/TouchScreen of your sewing machine.



GETTING READY TO SEW



UNPACKING

1. Place the machine on a sturdy, flat surface, remove the packaging and lift off the cover.
2. Remove the packing material and the foot control.
3. The machine is delivered with an accessory bag, a power cord and a foot control cord.
4. Wipe the machine, particularly around the needle and stitch plate to remove any soil before sewing.

Note: Your HUSQVARNA VIKING® OPAL™ sewing machine is adjusted to provide the best stitch result at normal room temperature. Extreme hot or cold temperatures can affect the sewn result.

PACKING AWAY AFTER SEWING

1. Press the ON/OFF switch to OFF.
2. Unplug the cord from the wall socket and then from the machine.
3. Unplug the foot control cord from the machine. Wind the foot control cord and place it inside the space on the underside of the foot control.
4. Check to ensure that all accessories are in the accessory box. Slide the box on to the machine, behind the free arm.
5. Place the foot control in the space above the free arm.
6. Put on the cover.

ACCESSORY TRAY

Store presser feet, bobbins, needles and other accessories in the accessory tray so that they are easily accessible.

Keep the accessory tray on the machine to provide a larger, flat work surface.

Note: The OPAL™ 690Q sewing machine comes with a removable presser feet and bobbin tray where you can store your accessories.

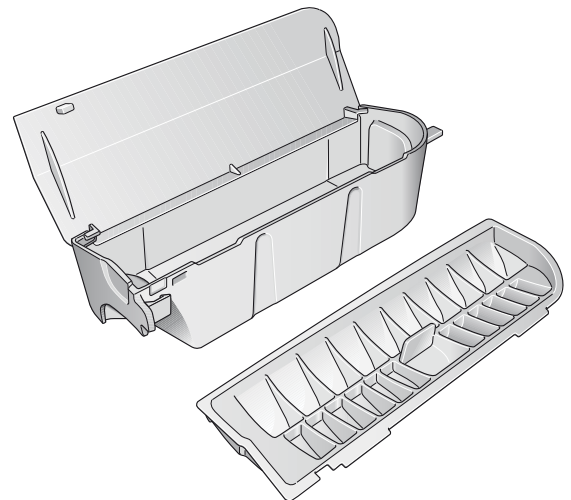

USING THE FREE ARM

Slide the accessory box to the left when you wish to remove it and use the free arm.

Use the free arm to facilitate sewing trouser legs and sleeve hems.

To replace the accessory box, slide it onto the machine until it fits in place.

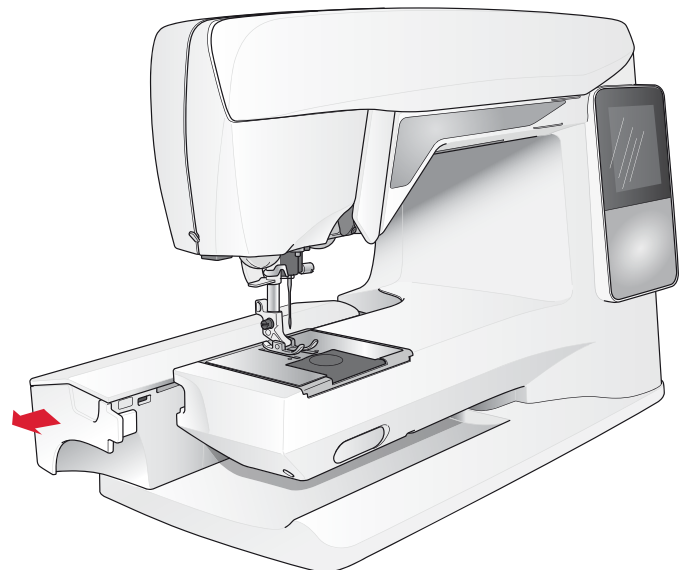

CONNECTING THE FOOT CONTROL CORD

Among the accessories you will find the foot control cord and the power cord. Connecting the foot control cord to the foot control is only necessary the very first time you are going to use the machine.

1. Take out the foot control cord. Turn the foot control over. Connect the cord to the socket inside the space of the foot control. Push firmly to make sure it is properly connected.
2. Lay the cord in the slot on the underside of the foot control.

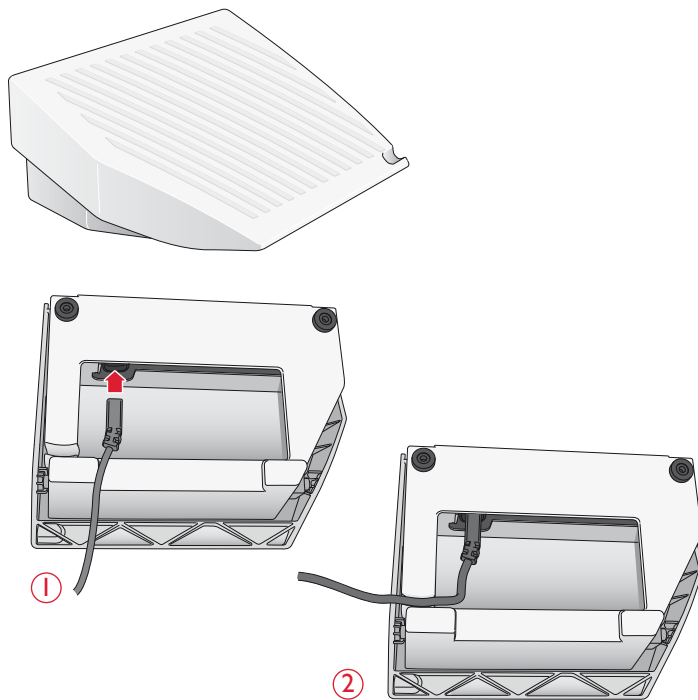

CONNECT THE POWER CORD AND FOOT CONTROL

On the underside of the machine you will find information about the power supply voltage (V) and the frequency (Hz).

Before plugging in the foot control, check to ensure that it is of type “FR2” (see underside of foot control).

1. Connect the foot control cord to the front socket on the bottom right side of the machine.
2. Connect the power cord to the rear socket on the bottom right side of the machine.
3. Press the ON/OFF switch to ON to turn on power and light.

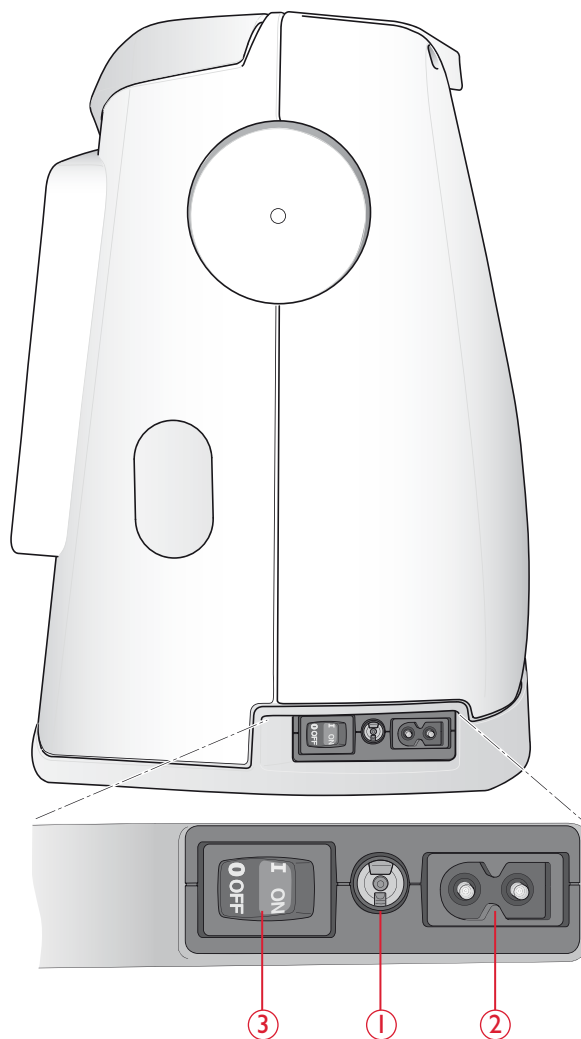

For the USA and Canada

This sewing machine has a polarized plug (one blade wider than the other). To reduce the risk of electric shock, this plug is intended to fit in a polarized outlet only one way. If the plug does not fit fully in the outlet, reverse the plug. If it still does not fit, contact a qualified electrician to install the proper outlet. Do not modify the plug in any way.

LOWER THE FEED TEETH

The feed teeth are lowered when you move the switch on the front of the free arm to the right. Move the switch to the left if you wish to raise the feed teeth. The feed teeth will raise as you begin to sew. The feed teeth should be lowered when sewing on buttons and for free motion sewing.

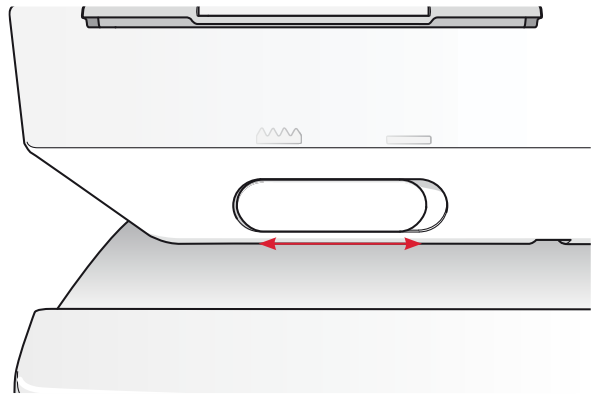

PRESSER FOOT PRESSURE (650/670)

Normal presser foot pressure is around five. The higher the number the more pressure the foot puts on the fabric. Knit and soft fabrics should be sewn at lower pressure.

The presser foot pressure is adjusted with the dial found under the lid. When adjusting the pressure lower the presser foot first.

Note: On 690Q the presser foot pressure is automatically set.

RAISE AND LOWER THE PRESSER FOOT (650/670)

The presser foot is raised and lowered with the presser foot lever (A). The presser foot must be lowered when sewing.

By raising the presser foot lever and then pressing it farther upwards, the lift height of the presser foot is increased to an extra height allowing you to slide very thick projects under the foot.

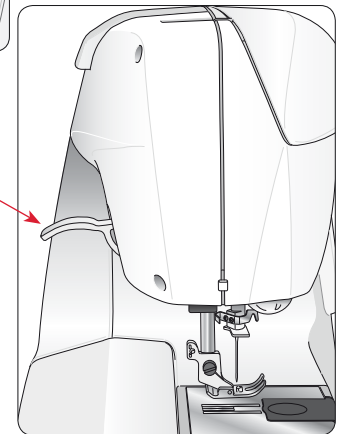
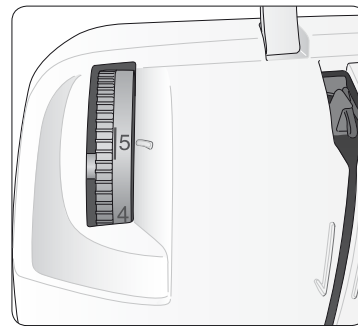

RAISE AND LOWER THE PRESSER FOOT (690Q)

Press the Sensor Foot Up/Extra Lift button to raise the presserfoot to the up position. Press the button once more and the presser foot will raise to the Extra Lift position, to make it easy to place and remove heavy or fluffy fabrics and battings under the presser foot.

Lower the presserfoot by pressing the Sensor Foot Down and Pivot button and the presser foot will be completely lowered so the machine firmly holds the fabric. Press Sensor Foot Down again to raise the presser foot to Pivot position or a floating position over the fabric for easier placement of the fabric.

You can also lower the presserfoot by tapping on your foot control.

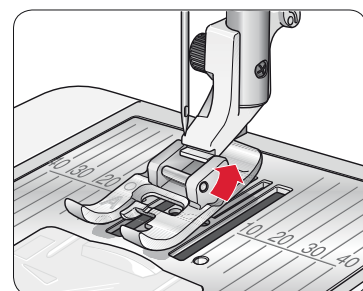
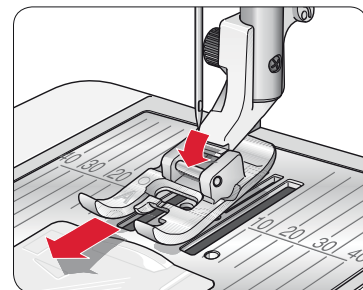

CHANGING THE PRESSER FOOT

⚠ Press the ON/OFF switch to OFF.

1. Make sure the needle is in the highest position and the presser foot is lifted. Pull the presser foot towards you.
2. Line up the cross pin on the foot with the gap in the presser foot ankle. Push back until the foot snaps into place.

CHANGING THE NEEDLE

 Press the ON/OFF switch to OFF.

1. Loosen the screw in the needle clamp with the screwdriver.
2. Remove the needle.
3. Push the new needle upwards with the flat side away from you until it will go no further.
4. Use the screwdriver to tighten the screw properly.

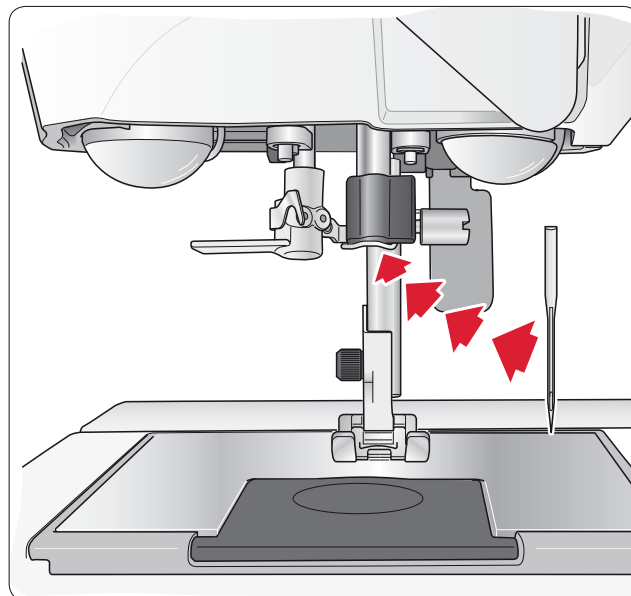

NEEDLES

The sewing machine needle plays an important role in successful sewing. To ensure you will get a quality needle, we recommend needles of system 130/705H.

Universal needle (A)

Universal needles have a slightly rounded point and come in a variety of sizes. For general sewing in a variety of fabric types and weights.

Stretch needle (B)

Stretch needles have a special scarf to eliminate skipped stitches when there is a flex in the fabric. For knits, swimwear, fleece, synthetic suedes and leathers. Marked with a yellow band.

Denim needle (C)

Denim needles have a sharp point to penetrate tightly woven fabrics without deflecting the needle. For canvas, denim, microfibers. Marked with a blue band.

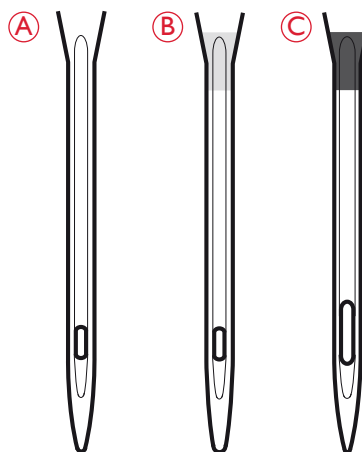

Tip: Read more about different needles in the HUSQVARNA VIKING® Accessory User's Guide at www.husqvarnaviking.com.

Note: Change the needle often. Always use a straight needle with a sharp point (1). A damaged needle (2) can cause skipped stitches, breakage of needles or snapping of thread. A damaged needle can also damage the stitch plate.

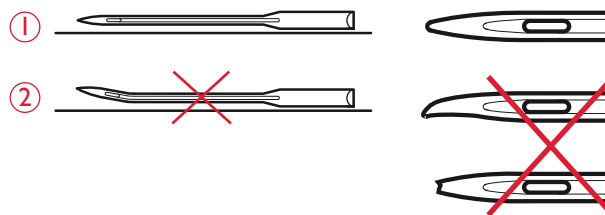

SPOOL PINS AND SPOOL CAPS

Your sewing machine has two spool pins, a main spool pin and an auxiliary spool pin. The spool pins are designed for all types of thread. The main spool pin is adjustable and can be used in a horizontal position (the thread reels off the stationary spool) or in a vertical position (the thread spool rotates). Use the horizontal position for all regular sewing threads and the vertical position for large spools or specialty threads.

Horizontal Position

Place a spool cap and the thread spool on the spool pin. Make sure that the thread reels off the spool counter clock-wise and slide on a second spool cap. Use a spool cap slightly larger than the thread spool.

The flat side of the spool cap should be pressed firmly against the spool. There should be no space between spool cap and thread spool.

A small spool cap is included as an accessory for your machine. The small spool cap can be used for small thread spools.

Note: Not all thread spools are manufactured in the same way. If you experience problems with the thread, turn it in the opposite way or use the vertical position.

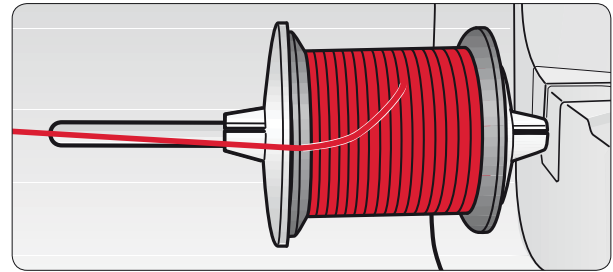

Vertical Position

Lift the spool pin up and all the way to the right. Lock the spool pin in the vertical position by slightly pressing it down. Slide on the large spool cap. For spools smaller than the medium size spool cap or when using specialty threads, place a felt pad under the thread spool to prevent the thread from reeling off too fast. For larger spools, the felt pad is not needed.

Note: No spool cap should be placed on top of the spool as this prevents the spool from rotating.

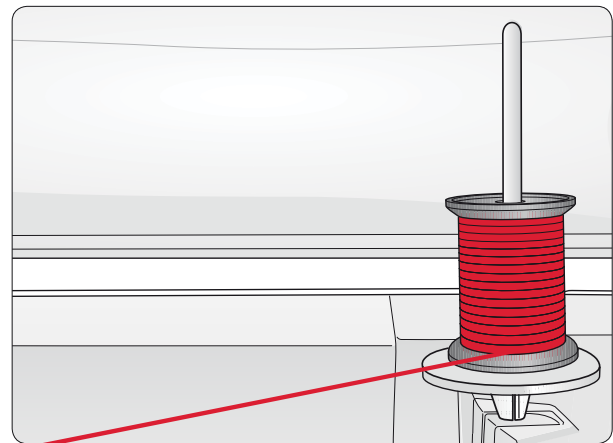

Auxiliary Spool Pin

The auxiliary spool pin is used when winding a bobbin from a second spool of thread or for a second spool when sewing with a twin needle.

Lift the auxiliary spool pin up and to the left. Slide on a spool cap. For spools smaller than the medium size spool cap, place a felt pad under the thread spool to prevent the thread from reeling off too fast. For larger spools, the felt pad should not be used.

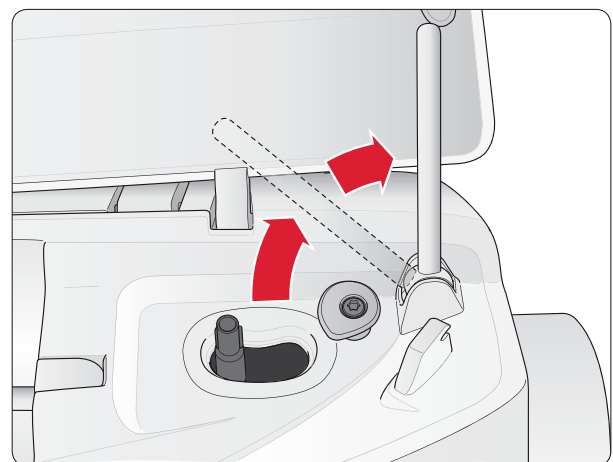

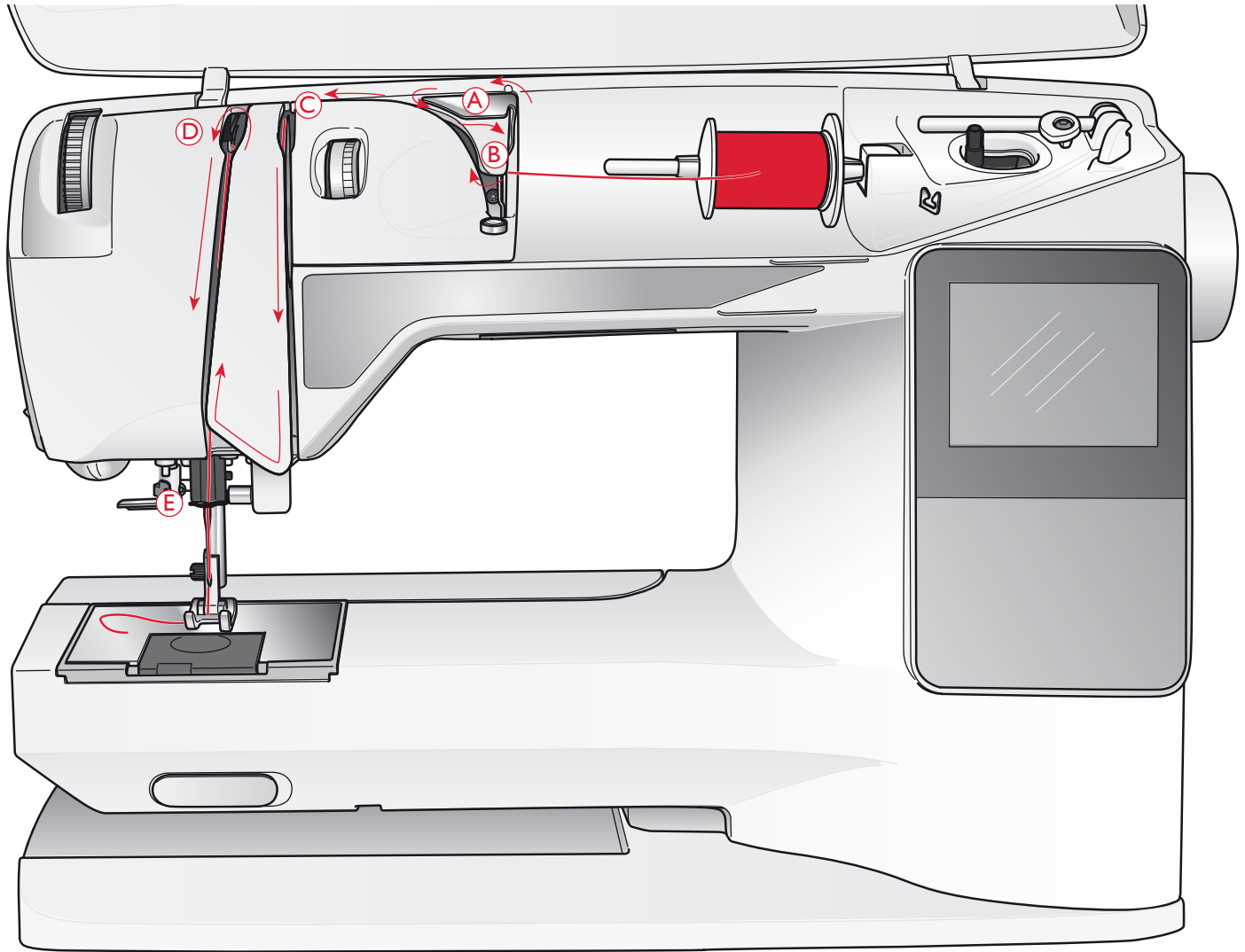

THREADING THE UPPER THREAD

Make sure the presser foot is raised and the needle is in the up position.

⚠ Press the ON/OFF switch to OFF.

1. Place the thread on the spool pin and the spool cap on the spool pin as described on page 16.
2. *Spool pin in horizontal position:*
Bring the thread over and behind the pre-tension thread guide (A) and under the thread guide (B).
Spool pin in vertical position:
Instead of bringing the thread into the pre-tension guide (A), bring it directly under the thread guide (B).
3. Bring the thread down between the thread tension discs (C).
4. Continue threading in the direction indicated by the arrows. Bring the thread from the right into the slot on the take-up lever (D).
5. Take the thread down and behind the last guide just above the needle (E).

NEEDLE THREADER

The needle must be in the up position to use the built-in needle threader. We also recommend lowering the presser foot.

1. Use the handle to pull the needle threader all the way down, catching the thread under the guide (A).
2. Push back to bring the needle threader forward until the metal flanges cover the needle. A small hook will pass through the needle eye (B).
3. Place the thread under the flanges in front of the needle, so the thread catches into the small hook (C).
4. Let the needle threader gently swing back. The hook pulls the thread through the needle eye and forms a loop behind the needle.
5. Pull the thread loop out behind the needle. Place the thread under the presser foot.

Note: The needle threader is designed to be used for size 70-120 needles. You cannot use the needle threader for size 60 needles or smaller, the wing needle, twin needle, triple needle or when the Sensor One-Step Buttonhole Foot is on. There are also some other optional accessories that require manual threading of the needle.

When threading the needle manually, make sure that the needle is threaded from front to back. The white presser foot ankle makes it easy to see the eye of the needle. The bobbin case cover can be used as a magnifying glass.

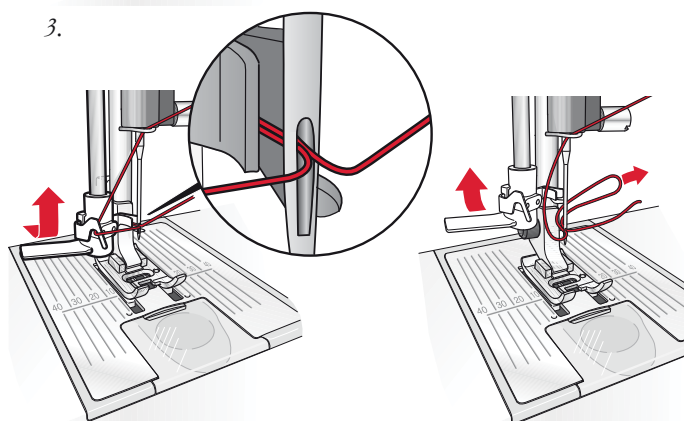
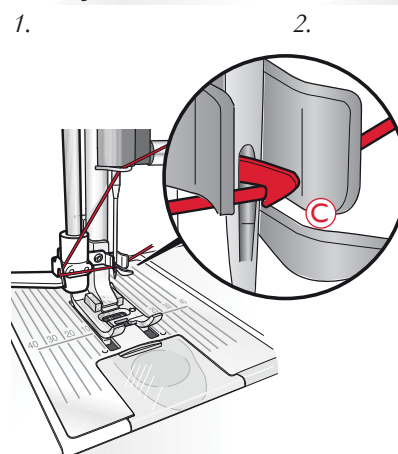
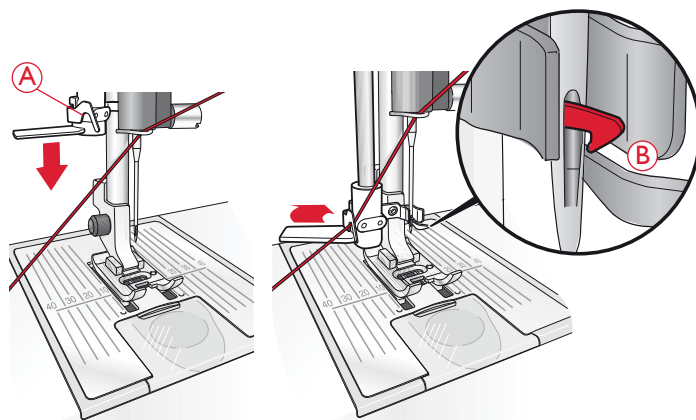

CUTTING THE THREAD

Once you have finished sewing, cut the threads by raising the presser foot and pulling the threads from the front to the back into the thread cutter on the left side of the machine.

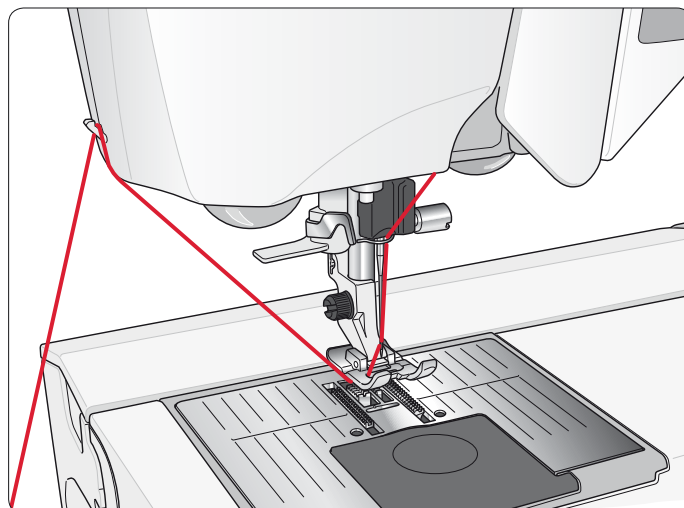

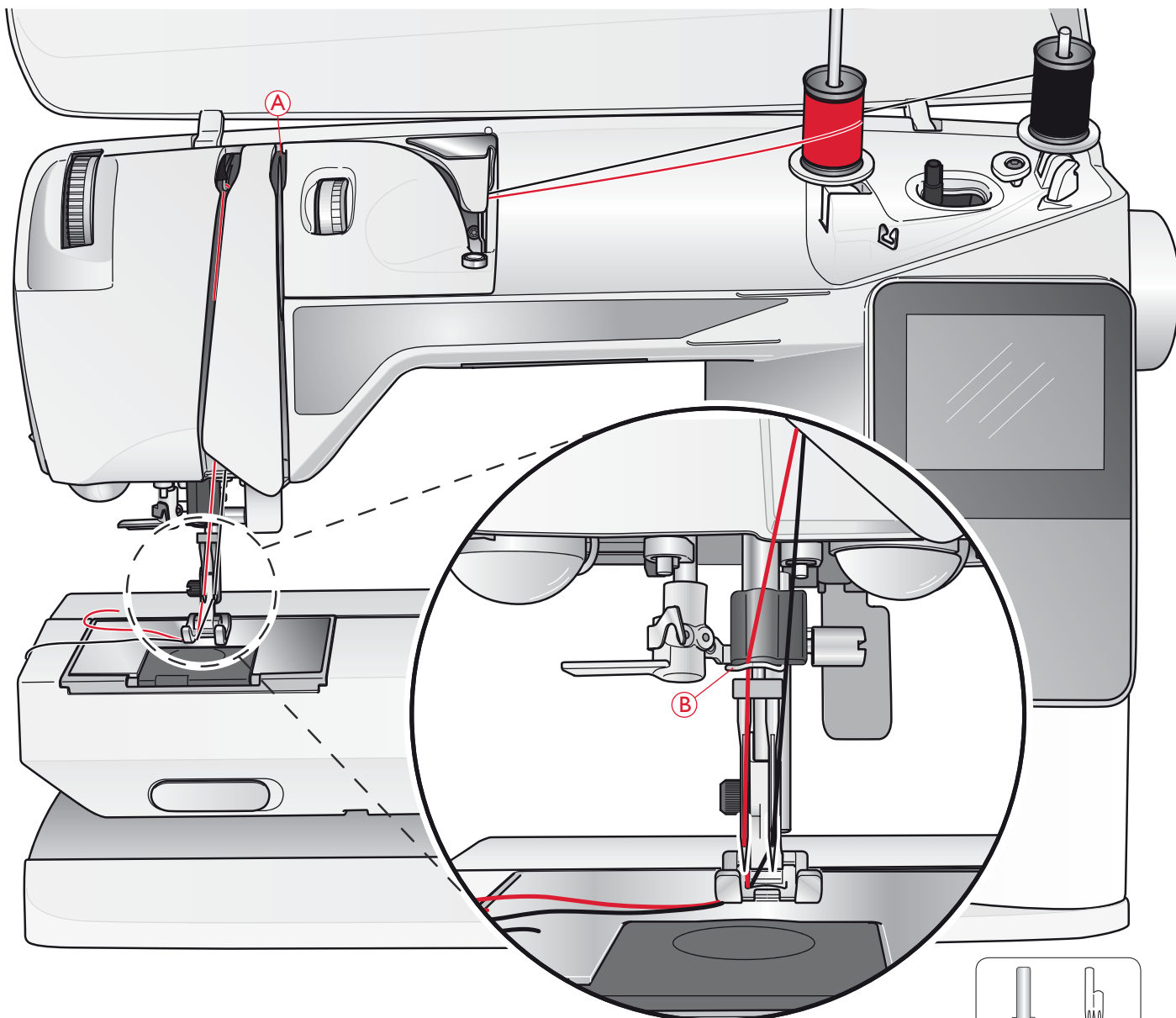

THREADING FOR TWIN NEEDLE

! Press the ON/OFF switch to OFF.

1. Insert a twin needle.
2. Use a second thread spool or wind a bobbin with the thread you are going to use as the second upper thread.
3. Lift the spool pin up and all the way to the right. Lock the spool pin in the vertical position by slightly pressing it down. Slide on a spool cap. For spools smaller than the medium size spool cap, place a felt pad under the thread spool.
4. Place the first thread spool on the spool pin. The spool should rotate in a *clockwise* direction when the thread reels off the spool.
5. *Left needle:* Thread the machine as described on page 17. Check to ensure that the thread lies between the left thread tension discs (A). Thread the left needle manually.

Note: Only use symmetrical twin needles (C). Do not use this type of twin needle (D), since it may damage your sewing machine.

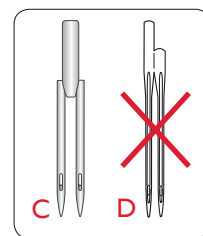

6. Pull out the auxiliary spool pin and slide on a spool cap. For spools smaller than the medium size spool cap, place a felt pad under the thread spool.
7. Place the second thread on the spool pin. The second spool should rotate in a *counterclockwise* direction when the thread reels off the spool.
8. *Right needle:* Thread the machine as before but this thread should lie between the right thread tension discs (A) and outside the needle thread guide (B). Thread the right needle manually.

Note: If using specialty threads (such as metallic threads) its weight and irregular surface increases the thread tension. By reducing the tension, the risk of needle breakage is prevented.

WINDING THE BOBBIN WITH THE MACHINE THREADED

Make sure that the presser foot is up and the needle is in the highest position.

Note! Do not use a plastic presser foot when bobbin winding.

1. Place an empty bobbin on the bobbin spindle on the top of the machine. The bobbin only fits on one way, with the logo facing up. Use only original HUSQVARNA VIKING® bobbins.
2. Pull the thread from the needle under the presser foot and to the right through the thread guide (C).
3. Guide the thread through the hole in the bobbin (D) from the inside to the outside.

Note: When using an earlier version of HUSQVARNA VIKING® bobbins that do not have a hole, wind several turns of thread on the bobbin to get started.

4. Push the bobbin spindle to the right. A pop-up message appears on the GraphicDisplay/TouchScreen. Hold the end of the thread firmly when starting to wind. Press the foot control to start winding. Once the bobbin begins to wind, cut the excess thread. When the bobbin is full it will stop rotating. Push the bobbin spindle back to the left, remove the bobbin and cut off the thread on the thread cutter.

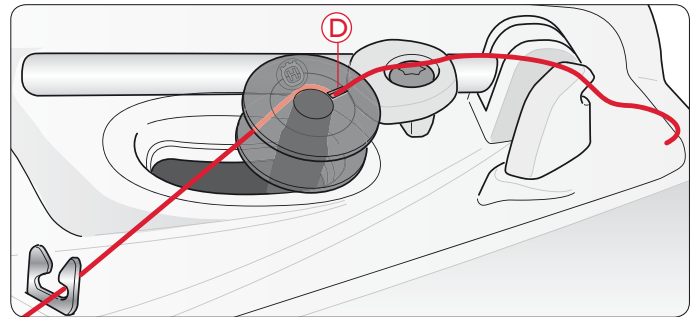
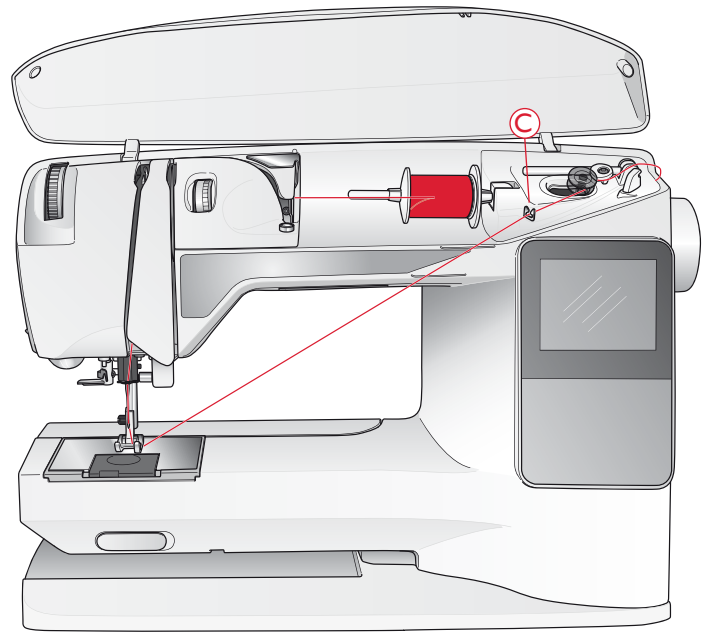

WINDING THE BOBBIN USING THE VERTICAL SPOOL PIN

1. Place an empty bobbin on the bobbin spindle on the top of the machine. The bobbin only fits on one way, with the logo facing up. Use only original HUSQVARNA VIKING® bobbins.
2. Place the large spool cap and a felt pad under the spool on the main spool pin set in the vertical position.
3. Bring the thread over and behind the pre-tension thread guide (A) and down around the thread tension disc (B), then through thread guide (C) as illustrated.
4. Guide the thread through the hole in the bobbin (D) from the inside to the outside.
5. Push the bobbin spindle to the right. A pop-up message appears on the GraphicDisplay/TouchScreen. Hold the end of the thread firmly when starting to wind. Press the foot control to start winding. Once the bobbin begins to wind, cut the excess thread. When the bobbin is full it will stop rotating. Push the bobbin spindle back to the left, remove the bobbin and cut off the thread on the thread cutter.

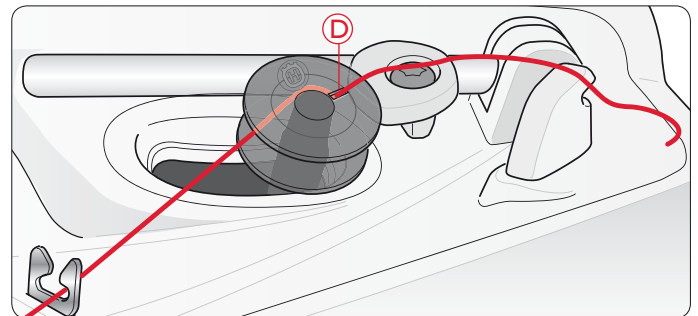
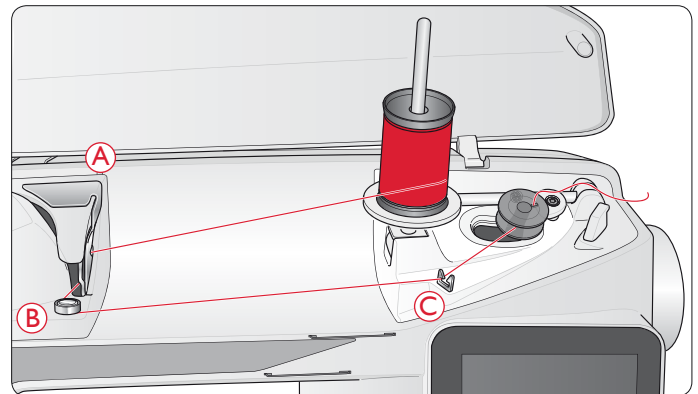

Note: When using an earlier version of HUSQVARNA VIKING® bobbins that do not have a hole, wind several turns of thread clockwise on the bobbin to get started.

WINDING THE BOBBIN USING THE AUXILIARY SPOOL PIN

1. Place an empty bobbin on the bobbin spindle on the top of the machine. The bobbin only fits on one way, with the logo facing up. Use only original HUSQVARNA VIKING® bobbins.
2. Fold out the auxiliary spool pin. Place a spool cap and a felt pad under the spool.
3. Bring the thread over and behind the pre-tension thread guide (A) and down around the thread tension disc (B), then through thread guide (C) as illustrated.
4. Guide the thread through the hole in the bobbin (D) from the inside to the outside.
5. Push the bobbin spindle to the right. A pop-up message appears on the GraphicDisplay/TouchScreen. Hold the end of the thread firmly when starting to wind. Press the foot control to start winding. Once the bobbin begins to wind, cut the excess thread. When the bobbin is full it will stop rotating. Push the bobbin spindle back to the left, remove the bobbin and cut off the thread on the thread cutter.

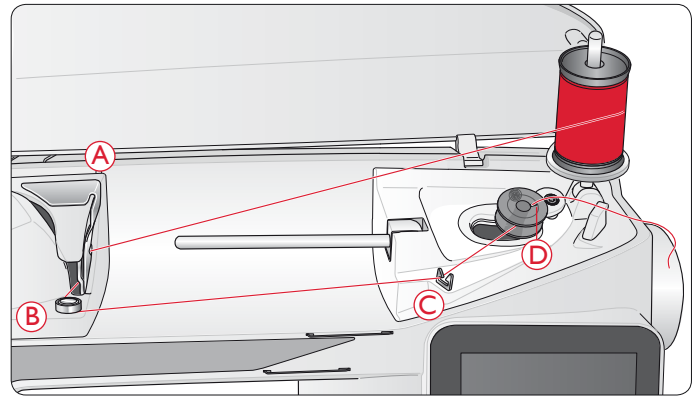

INSERTING THE BOBBIN

! Press the ON/OFF switch to OFF.

1. Remove the bobbin cover by sliding it towards you.
2. Place the bobbin in the bobbin case. It drops in only one way with the logo facing up. The thread unreels from the left of the bobbin. The bobbin will then rotate counter-clockwise when you pull the thread.
3. Place your finger on the bobbin to keep it from turning as you pull the thread firmly to the right and then to the left into the tension spring (E) until it “clicks” into place.
4. Continue threading around (F) and to the right of the thread cutter (G). Slide on the bobbin cover (H). Pull the thread to the left to cut (I).

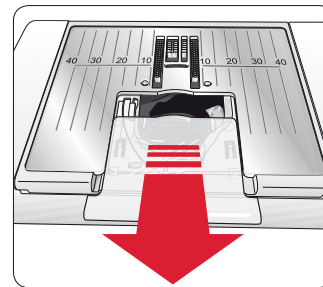

1.

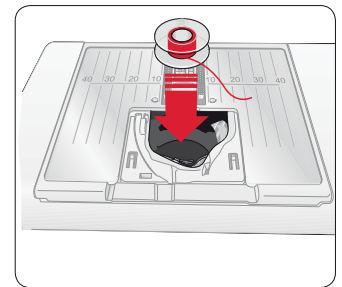

2.

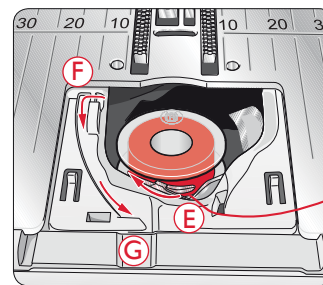

3.

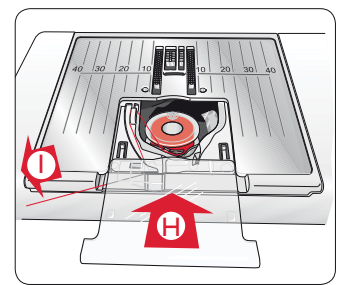

4.

THREAD TENSION (650)

Use the recommended top thread tension setting given on the GraphicDisplay. You might need to adjust the top thread tension for special threads, fabrics and/or techniques. To set the tension, turn the numbered tension dial. The higher the number the tighter the tension.

Normal top thread tension is set to 4-6. When sewing buttonholes and decorative stitches set thread tension to around 3. When topstitching with a heavy weight thread in thick fabric, increase the tension to 7-9. Thread tension recommendation is always given on the GraphicDisplay for the selected stitch and fabric.

Make a few tests on a scrap piece of the fabric you are going to sew and check the tension.

AUTOMATIC THREAD TENSION (670/690Q)

Your machine automatically sets the best thread tension for the selected stitch and fabric. The thread tension shown on the touchscreen can be adjusted for specialty thread, techniques or fabric. Touch + to increase the thread tension and - to decrease it.

Correct and Incorrect Thread Tension

To understand the correct thread tension, sew a few sample straight stitches at different settings.

1. Begin with a tension that is too loose, i.e. set at the lowest number. The bobbin thread will lie straight and the top thread will be drawn to the underside of the fabric.
2. If you set the tension at the highest number, the bobbin thread will be visible on the top side of the fabric. The seam may pucker and the top thread might break.
3. The correct thread tension is set when the threads interlock in between both fabric layers or, in the case of decorative stitches, on the underside.

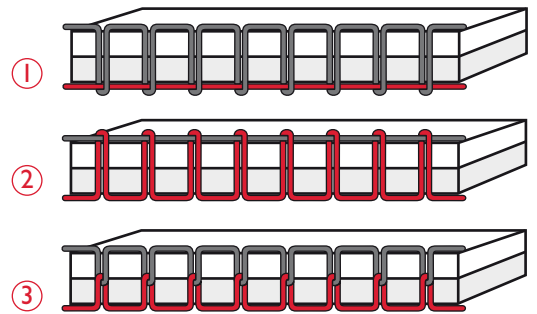

EXCLUSIVE SENSOR SYSTEM™ (ESS) (690Q)

Sensor Foot Pressure (P-foot pressure)

With the Sensor Foot Pressure, the presser foot actually senses the thickness of fabric to sew smoothly and evenly with perfect fabric feeding.

If you want to see the actual setting of the presser foot pressure for the selected fabric and adjust the pressure manually, go to the SET Menu.

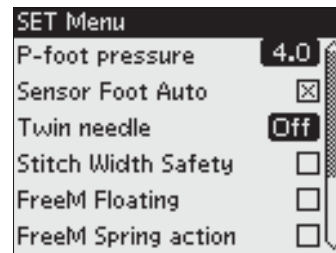

Sensor Foot Lift

The presser foot on your sewing machine is raised and lowered in four levels with the Sensor Foot Up and Down buttons.

The presser foot is automatically lowered when you start sewing.

When you stop with the needle in the down position, the presser foot automatically senses the thickness of the fabric and raises the presser foot to just the right height to float over the fabric for pivoting. Go to the SET Menu to turn off the Sensor Foot Auto function.



STARTING TO SEW

A straight stitch is selected by default when you turn on the machine. Before starting to sew, select your fabric type in the Exclusive SEWING ADVISOR™ feature, and set your machine according to the recommendations on the GraphicDisplay/ TouchScreen (page 44).

To start sewing, place top and bobbin thread under the presser foot and to the back. For best results when beginning at the edge of the fabric, place a finger on the threads to hold them in place as you begin.

Place fabric in position under the presser foot. If you own a 650/670 machine, lower the presser foot with the presser foot lifter and step on the foot control to begin sewing. If you own a 690Q machine, simply press down the foot control or use the presser foot down button, and the presser foot will lower. Guide the fabric gently with your hands as the machine is feeding.

See page 28 (650)/37 (670/690Q) for reference on how to select another stitch or how to use the Exclusive SEWING ADVISOR™ feature (page 44).

OPERATING YOUR OPAL™ 650 SEWING MACHINE



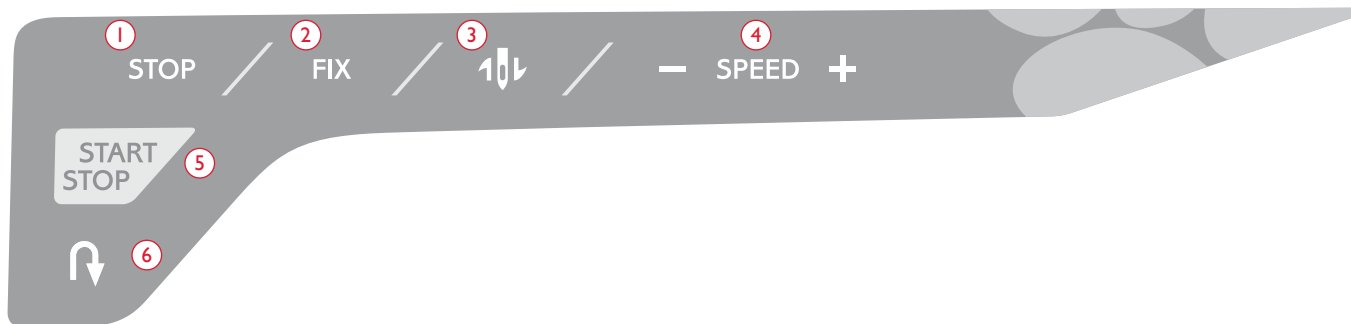

FUNCTION PANEL (650)

1. STOP

STOP is used to conclude a stitch or to sew just one unit of the stitch. Your sewing machine ties off the thread and stops automatically when one stitch unit or stitch program has been completed. STOP is cancelled once you have used the function. Press again if you wish to activate it once more. When activated, a STOP icon is visible on the GraphicDisplay.

STOP is also used to repeat the same size darning and bartack stitch.

Tip: If you want to repeat the STOP function for a stitch unit several times in a row you can save the stitch with a STOP at the end in a program (see Programming, page 29).

2. FIX

By using the FIX function you can lock the stitch at the beginning and/or at the end. Press FIX again to turn off the function.

When activated, a FIX icon is visible on the GraphicDisplay.

The FIX function is automatically activated when a stitch is selected or when STOP has been used. You can turn off the automatic FIX function in the SET Menu, see page 32.

The FIX function can be programmed (see page 29).

3. Needle Stop Up/Down

Press Needle Stop Up/Down to move the needle down or up. The setting of the needle stop position is changed at the same time.

An arrow pointing up or down, next to the needle on the GraphicDisplay indicates if Needle Stop Up or Needle Stop Down is selected.

You can also tap the foot control to raise or lower needle.

4. SPEED

All stitches in your sewing machine have a pre-set, recommended sewing speed. Press SPEED + or SPEED – to increase or decrease the sewing speed. There are five speed levels. The speed level is shown on the GraphicDisplay. You cannot select a higher speed than the default max speed for the selected stitch.

5. START/STOP

Press START/STOP to run and stop the machine without the foot control. Press once to begin sewing and press again to stop sewing.

6. Reverse

Press Reverse while sewing and the machine will sew in reverse until released. Then your sewing machine will sew forward. For permanent reverse, press Reverse once before starting to sew. Your sewing machine sews in reverse until you press Reverse again.

When activated, a reverse icon is visible on the GraphicDisplay.

Reverse is also used when sewing buttonholes, bartacks and darning to step between the parts of the stitch.

FUNCTIONS ON THE TOUCH PANEL

7. ALT (Alternate View)

When you select a satin stitch the length and width settings will be shown on the GraphicDisplay. By pressing ALT the density setting will be shown instead of the length setting.

8. Stitch Length/Density

When you select a stitch, your machine automatically sets the best stitch length. The stitch length is visible on the GraphicDisplay. You can change the stitch length by pressing – or +.

If you have selected a buttonhole the GraphicDisplay will show the density setting instead of the stitch length setting. You will now be able to change the density setting by pressing – or +.

If you press the ALT the GraphicDisplay will show the density setting for satin stitches. Use the – and + to change the setting.

9. Stitch Width/Needle position

The stitch width is set in the same manner as the stitch length. The preset width is visible on the GraphicDisplay. The width can be adjusted between 0 and 7 mm. Some stitches have a limited stitch width.

If a straight stitch is selected, – and + are used to move the needle to the left or right in 29 positions.

10. Mirror Side to Side

Press to mirror the selected stitch side to side. In straight stitch, with a left needle position, touching this icon will move the needle from the left to the right symmetrically across the center position. If pressed in Sewing Mode for stitch programs, the whole stitch program is mirrored. The change is visible on the GraphicDisplay.

11. Navigator Arrows

Make your selections with the Navigator Arrows and confirm your selections or changes with OK.

Use the left/right Navigator Arrows to select stitches step by step in numerical order within the selected stitch menu.

The Navigator Arrows are also used when programming to select stitches within the program or to select letters to insert in the program.

The up and down Navigator Arrows are also used to set the size of a buttonhole and to set the number of stitches when sewing on a button.

12. Stitch Selection Numbers

By pressing one digit or two digits in quick succession you will be able to select a stitch from the selected stitch menu. If the stitch number does not exist in the selected stitch menu, the machine beeps.

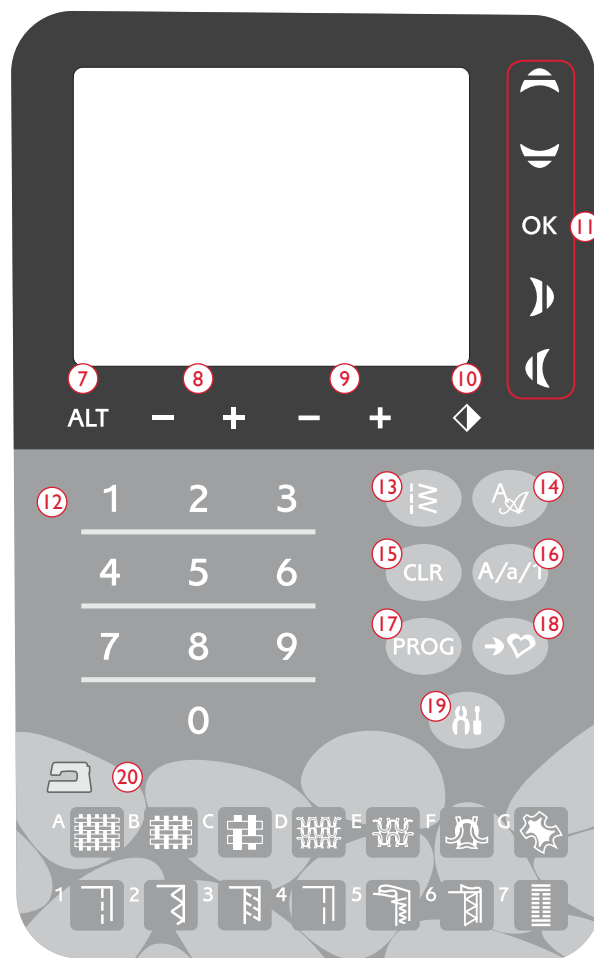

13. Stitch Menu

Press to open the Stitch Selection Menu.

14. Font Menu

Press to open the Font Menu to select a font.

15. CLR (Clear)

Press CLR to delete a single stitch or all stitches in a stitch program. Or use it to delete your saved stitches and stitch programs in the My Stitches Menu.

16. Shift to Upper-Case, Lower-Case or Numbers

Press to shift to lower or upper-case or numbers when programming letters.

17. PROG (Program Mode)

Press PROG to open the mode for programming. Press the button again to exit the program mode.

18. Save to My Stitches

Press to open the menu where you can save your own personal stitches or stitch programs. Press again to exit the My Stitches mode.

19. SET Menu

Press to open the menu for machine settings. Make changes and selections by using the Navigator Arrows (11). Press again to exit the SET Menu. Read more about the settings made in the SET Menu on page 32.

20. Exclusive SEWING ADVISOR™

The Exclusive SEWING ADVISOR™ feature sets the best stitch, stitch length, stitch width and sewing speed for the selected fabric and sewing technique. The stitch is shown on the GraphicDisplay with presser foot, presser foot pressure, thread tension and needle recommendations. Press the symbols for the fabric you are using and the sewing technique you wish to sew (see page 44).

SEWING MODE (650)

Sewing Mode is the first view on the GraphicDisplay after you turn on the machine. Here you will find all the basic information you need to start sewing. This is also the menu where you adjust the settings of your stitch. Straight stitch is selected by default.

Note: When the value for stitch length/width/density or needle position is set to default the figures will be black. If you change the value, the figures will be inverted on a black background.

1. Recommended needle for the selected fabric. An arrow next to the needle icon indicates if needle up/down is selected.
2. Recommended thread tension for the selected fabric and stitch.
3. Recommended presser foot for the selected stitch.
4. The sewing speed is indicated by five levels shown on the GraphicDisplay. Reduce or increase the speed by pressing SPEED + or SPEED – (see page 24).
5. The fabric and sewing technique selected on the Exclusive SEWING ADVISOR™ feature.
6. Recommended presser foot pressure.
7. The selected stitch, both illustrated and displayed by number.
8. Stitch length. Reduce or increase the stitch length by pressing – or + (see page 25).
9. Needle position is shown instead of stitch width when straight stitch is selected. Change the needle position by pressing – or + (see page 25).

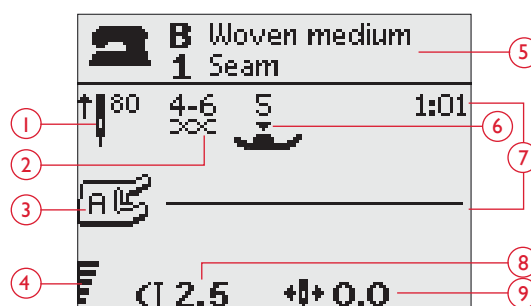

Normal Sewing Mode, Straight stitch

10. Indicates that a Stretch 90 needle should be used.
11. Recommendation to use stabilizer under your fabric.
12. Recommendation to use self adhesive glide plates (see page 5).
13. Stitch width. Reduce or increase the stitch width by pressing – or + (see page 25).
14. Indicates that the function Mirror Side to Side is activated.



Normal Sewing Mode, Decorative stitch

15. When sewing buttonholes in stretch fabric we recommend to cord the buttonhole for better durability, see page 49.
16. When sewing a manual buttonhole or the darning program the reverse icon is shown to indicate that you need to press Reverse when the buttonhole columns or the darning stitch are sewn to the desired length.
17. Stitch density is shown instead of stitch length when a buttonhole, bartack or darning stitch is selected or when a satin stitch is selected and ALT is pressed. Reduce or increase the stitch density by pressing Stitch Length – and +.



Manual Buttonhole

18. Buttonhole size indication when using the Sensor One-Step Buttonhole Foot. Set the size of the button by pressing the up and down Navigator Arrows. Confirm with OK.



Sensor One-Step Buttonhole

19. The icon for removing the presserfoot is shown when sewing on buttons is selected.
20. The icon for lowering the feed teeth is shown when sewing on buttons is selected.
21. Set the number of stitches to sew on the button by pressing the up and down Navigator Arrows.
22. Recommendation to use the multipurpose tool (optional accessory, part number 4131056-01) when sewing on a button. Place the thin end of the multipurpose tool under the button when sewing on light fabrics. Use the thick end for heavier fabrics.

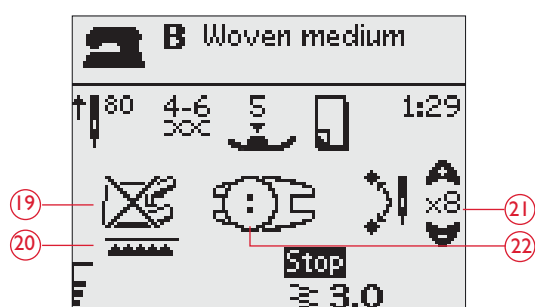

Sewing on button

SELECTING A STITCH

Press Stitch Menu (A) to select a stitch menu. Use the Navigator Arrows to select among the menus:

1. Utility stitches
2. Quilt stitches
3. Decorative stitches
4. Decorative stitches
5. My Stitches

The name and number of the selected menu is shown at the bottom of the display. The stitches are pictured inside the lid of your machine with the menu numbers on the left and the stitch numbers within the menus across the center.

When you have selected the menu, press the number of the stitch you wish to use with the Stitch Selection Numbers, or press OK and the first stitch in the selected menu will be selected.

By pressing two digits in quick succession you will be able to select a stitch from 10 and up from the selected stitch menu. If the stitch number does not exist in the selected menu you will hear a beep and the first entered digit will be selected as a stitch.

Press Stitch Menu again to close the selection menu without making any selection.

The selected stitch menu, stitch and stitch number will be visible on the GraphicDisplay in Sewing Mode. To select another stitch in the same menu just press the number of the stitch or use the left and right Navigator Arrows to step stitch by stitch in numerical order. To select a stitch in another menu you will first need to change stitch menu and then select the stitch.

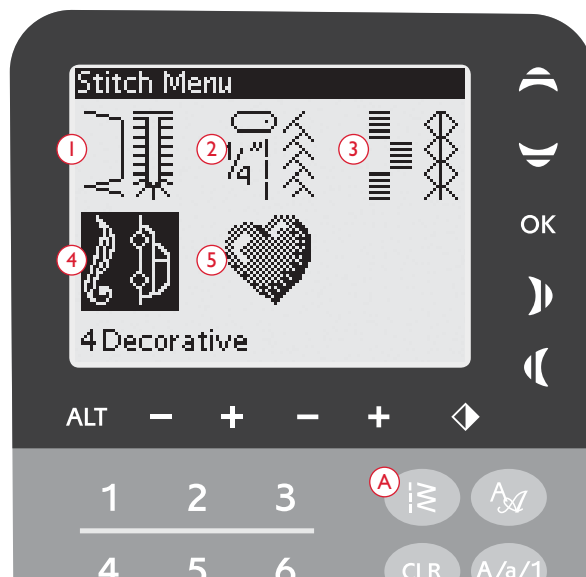

SELECTING A FONT

Press Font Selection Menu (B) to show and select among the different fonts. Use the Navigator Arrows to select among the fonts:

Block, Cyrillic, Hiragana

Press OK, this automatically opens the mode for programming letters, see page 29.

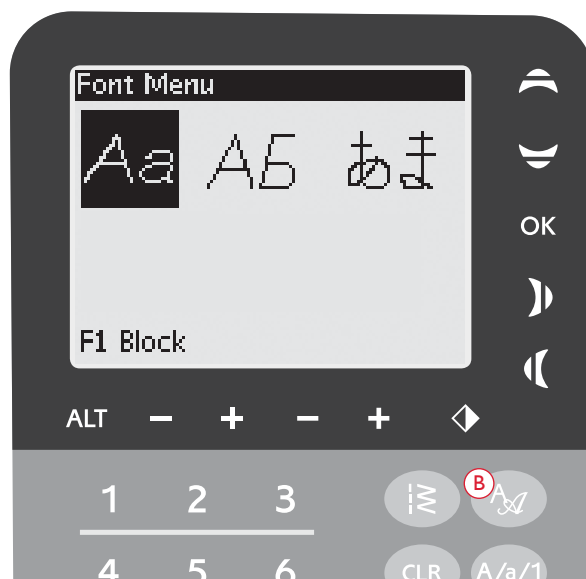

PROGRAMMING (650)

The Programming function on your machine makes it possible to create stitches with your own personal settings and to combine stitches and letters into stitch programs. You can add up to 20 stitches and letters in the same program. Save your own stitches and programs in My Stitches and recall them any time you like.

All stitches in your sewing machine are programmable except for buttonholes, darning, button sewing and bartacks.

Create a Stitch Program

1. Press PROG (C) to open the mode for Programming.
2. The stitch menu which was previously selected will be kept when entering the Programming mode. To change the stitch menu see page 28.
3. Select the stitch you wish to use. The stitch will appear in Programming Mode.
4. Select the next stitch and it will appear to the right of the last entered stitch.

Note: Two numbers are displayed above the stitch program on the left side of the GraphicDisplay.

The first number is the position of the selected stitch in the program. The second number, put in brackets, is the total number of stitches in the program. The number above the stitch program on the right side of the GraphicDisplay is the number of the selected stitch.

Add Letters

5. Select a font and press OK. The machine will show the upper case alphabet in Programming Mode.
6. Use the Navigator Arrows to select a letter and press OK to add the letter to the program.
7. To switch to a lower case alphabet or numbers press Shift (see page 25).

About Programming Letters

Both upper and lower case letters will be stitched with a 7 mm stitch width. If there are letters going below the baseline included in the program (e.g. j, p, y) the height of the uppercase letters will be reduced.

All text to be sewn out on the same project should, if possible, be in the same program to ensure the letters are sewn out in the same height.



Programming Mode



Husqvarna VIKING
"Husqvarna" and "VIKING" have been programmed separately.

Husqvarna VIKING
"Husqvarna" and "VIKING" are in the same program.

Add Stitches or Letters at other Positions

If you wish to add a stitch or letter at another position in the program, move the cursor by pressing the Navigator Arrows. The stitch or letter will be inserted to the right of the cursor.

Note: When programming letters, press the down Navigator Arrow to activate the cursor in the stitch program instead of in the alphabet.

Add the Same Stitch Several Times

If you want to add the same stitch several times in a row you can just press OK directly after the first stitch has been inserted. The same stitch will be inserted each time you press OK.

You can also move the cursor to select another stitch and press OK. The selected stitch will be inserted once more to the right of the selected stitch.

Delete Stitches or Letters

To delete a stitch in the program, select the stitch with the cursor by pressing the Navigator Arrows and press CLR.

To delete the whole program, move the cursor to the left of the first position and press CLR. A pop-up will appear asking you to verify the deletion. Select Yes or No with the Navigator Arrows and press OK.

Add Commands

The FIX and STOP functions can be added to the program. Each command takes one memory space in the program. To add any of the above functions to your program just press the corresponding function on the Function Panel (see page 24).

Note: If autofix is activated on your machine you do not need to add a FIX in the beginning of the program.

Join Two Stitch Programs Into One

You can add a previously saved program to a new one in Programming Mode. Press Stitch Menu, select My Stitches and the program you wish to add. Press OK and the program will be inserted in Programming Mode to the right of the cursor.

Adjust a Single Stitch or Letter

To adjust the settings of a single stitch in a program you must select the stitch in Programming Mode. You can adjust the stitch width, stitch length, density, needle position or mirror the stitch. The settings for the selected stitch are shown on the GraphicDisplay. Press ALT to toggle between different settings.

Adjust the Entire Stitch Program

Adjustments that affect the whole program and not just single stitches, are done in Sewing Mode. Press PROG to leave Programming Mode and switch to Sewing Mode. In Sewing Mode you can adjust the width and length or mirror the whole program.

There are a few things you need to know when adjusting the stitch program in Sewing Mode:

The adjustments you make to the program in Sewing Mode can be saved to My Stitches. However, these adjustments cannot be brought back to Programming Mode. If you have made adjustments in Sewing Mode and press PROG to go back to Programming Mode, these adjustments will be cancelled. This will also happen if you load a saved program from My Stitches to Programming Mode.

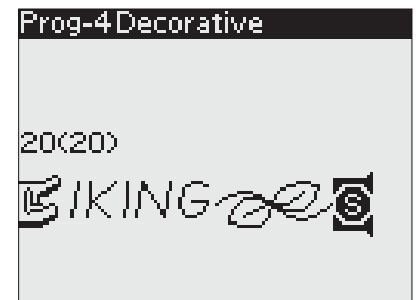

Add commands



Adjust a single stitch or letter

Sew out the Stitch Program

When you are done with your program press My Stitches to save it (see below) or, if still in Programming Mode, press PROG or step on the foot control to switch to Sewing Mode.

Once you are in Sewing Mode and step on the foot control the machine will sew out your stitch program. The program will be sewn continuously if no STOP is programmed. Press STOP to sew your stitch program only once.

It is possible to start sewing at any stitch in the program. Use the left/right Navigator Arrows to step through the program in Sewing Mode.

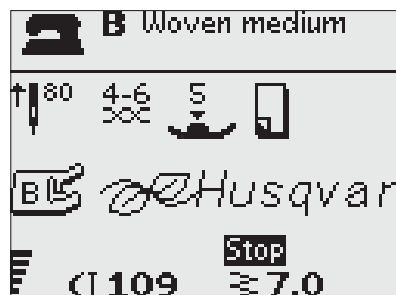

Sewing Mode

MY STITCHES MENU

My Stitches is your own personal menu where you can save and recall your programs or favorite stitches with personal settings.

Model 650 has 4 memories. Each memory has a maximum space of 20 stitches.

Save a Stitch or a Program

Press My Stitches (D) from Programming or Sewing Mode. This will open the My Stitches Menu. Select an empty memory by pressing the up/down Navigator Arrows. Confirm your selection by pressing OK. If the selected memory is not empty, a pop-up message will appear asking if you wish to overwrite the previously saved stitch/program with the new one. Select Yes or No with the Navigator Arrows and press OK. Press My Stitches again to return to Sewing Mode or Programming Mode.



Load a Saved Stitch or Program

To load a saved stitch or program from My Stitches, press Stitch Selection Menu and open the My Stitches Menu. Use the Navigator Arrows to select the stitch or program and press OK. The stitch/program will appear in Sewing Mode ready to be sewn.



Delete Saved Stitches or Programs

To delete a stitch or a program from My Stitches, press CLR when the stitch/program is selected. A pop up will appear asking you to verify the deletion. Select Yes or No with the Navigator Arrows and press OK. Press My Stitches again to return to the previous menu.



SET MENU

You can change the pre-set machine settings and make manual adjustments to the automatic functions in the SET Menu. Open the menu by pressing SET Menu (E). Select the setting you wish to adjust by pressing the up/down Navigator Arrows. To activate the function, press OK to place an X in the box. To cancel the function, press OK again to leave the box empty. Use the right/left Navigator Arrows to change the number settings by toggling through the available options. Press SET Menu again to close the SET Menu.

Note: When a number is set to default the figures will be black. If you change the number the figures will be inverted on a black background.

FIX Auto

Press OK to turn on or off the automatic FIX function in the beginning of each stitch. The settings are saved when turning off the machine.

Twin Needle

If you are using a twin needle, set the size of the needle to limit the width of all stitches and prevent needle breakage.

Activate or deactivate the twin needle function with OK and use the left/right Navigator Arrows to set the twin needle size.

Your setting will be saved also when the machine is turned off. A pop-up message reminds you of the setting when you turn on the machine. Close the pop-up message by pressing OK.

Note: You cannot set the twin needle size if the Stitch Width Safety is on, or turn on the Stitch Width Safety if the machine is set for twin needle.

Stitch Width Safety

Use OK to turn on the Stitch Width Safety when using a straight stitch needle plate or a straight stitch presser foot.

The stitch width will be limited to zero for all stitches to prevent damage to the needle, presser foot and needle plate. This setting is saved when the machine is turned off. A pop-up message reminds you of the setting when you turn on the machine. Close the pop-up message by pressing OK.

Audible Alarm

Turns on or off all alarm sounds of the machine. Default setting is on. This setting is saved even if the machine is turned off.

Contrast

Adjust the contrast of the GraphicDisplay by using the left/right Navigator Arrows.

The value can be set between -20 to 20 in steps of 1. The setting is stored even when the machine is turned off.

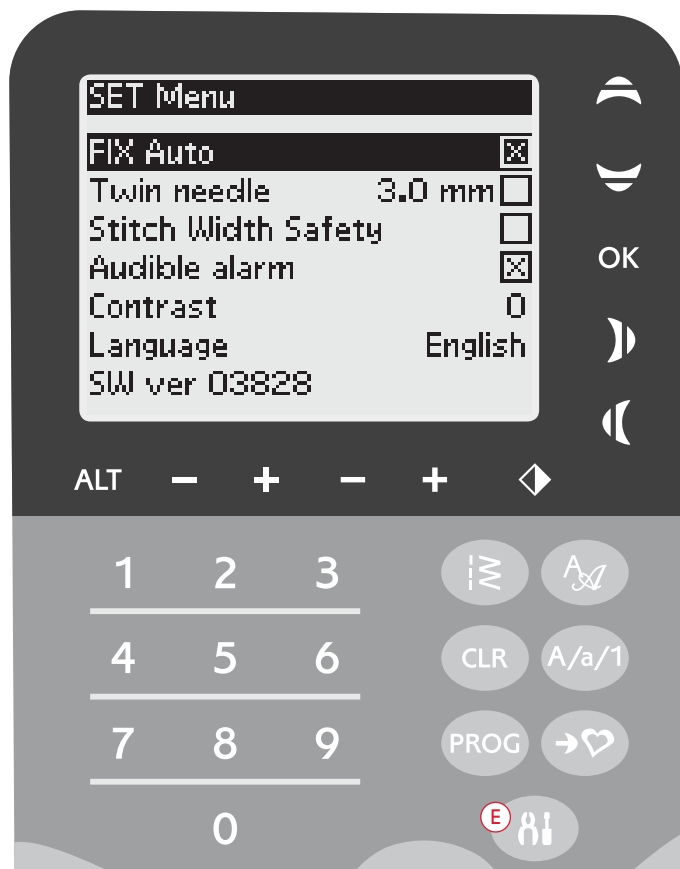

Language

Use the left/right Navigator Arrows to change the language of all text in your machine.

The language setting is saved even if the machine is turned off.

Software Version

The software version currently loaded for the sewing machine is displayed.

OPERATING YOUR OPAL™ 670/690Q SEWING MACHINE



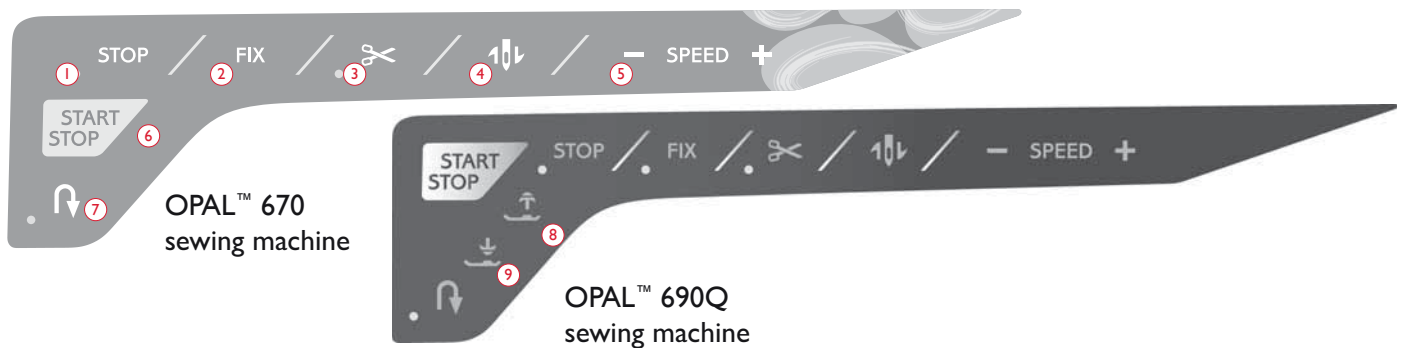

FUNCTIONS PANEL (670/690Q)

1. STOP

STOP is used to conclude a stitch or to sew just one unit of the stitch. Your sewing machine ties off the thread and stops automatically when one stitch unit or stitch program has been completed. The LED next to STOP is lit when the function is activated. STOP is cancelled once you have used the function. Press again if you wish to activate it once more.

STOP is also used to repeat the same size darning, bartack and Automatic Tapering stitch with the same size.

Tip: If you want to repeat the STOP function for a stitch unit several times in a row you can save the stitch with a STOP at the end in a program (see Programming, page 38).

2. FIX

By using the FIX function you can lock the stitch at the beginning and/or at the end. The LED next to FIX is lit when FIX is activated. Press FIX to turn off the function.

The FIX function is automatically activated when a stitch is selected or when STOP or the Thread Cutter has been used. You can turn off the automatic FIX function in the SET Menu, see page 42.

The FIX function can be programmed (see page 39).

3. Thread Cutter

Press the Thread Cutter and your machine ties off the threads and cuts the top and bottom threads and activates the FIX function for the next start. To cut threads at the end of a stitch or stitch program, press the Thread Cutter while sewing. The LED next to the Thread Cutter starts flashing indicating that a cut is requested. When the stitch or stitch program is completed, the upper thread and bobbin will be cut and the thread ends are automatically pulled to the underside of the fabric.

The Thread Cutter function can be programmed (see page 39).

4. Needle Stop Up/Down

Press to move the needle up or down. The setting of the needle stop position is changed at the same time.

An arrow pointing up or down next to the needle on the TouchScreen indicates if Needle Stop Up or Needle Stop Down is selected.

You can also tap the foot control to raise or lower needle.

5. SPEED

All stitches in your sewing machine have a pre-set, recommended sewing speed. Press SPEED + or SPEED – to increase or decrease the sewing speed. There are five speed levels. The speed level is shown on the TouchScreen. You cannot select a higher speed than the default max speed for the selected stitch.

6. Start/Stop

Press START/STOP to run and stop the machine without the foot control. Press once to begin sewing and press again to stop sewing.

Note: Press SPEED + or SPEED – to increase or decrease the sewing speed.

7. Reverse

Press Reverse while sewing and the machine will sew in reverse until released. Then your sewing machine will sew forward. The LED next to Reverse is lit when reverse is activated.

For permanent reverse, press Reverse once before starting to sew. Your sewing machine sews in reverse until you press Reverse again.

Reverse is also used when sewing buttonholes, bartacks, darning and automatic tapering stitches to step between the parts of the stitch.

8. Sensor Foot Up/Extra Lift button (690Q)

This button raises the presser foot to the up position. Press the button once more and the presser foot will raise to the Extra Lift position, to make it easy to place and remove heavy or fluffy fabrics and battings under the presser foot.

9. Sensor Foot Down/Pivot Position button (690Q)

Press Sensor Foot Down and Pivot and the presser foot will be completely lowered so the machine firmly holds the fabric. Press Sensor Foot Down again to raise the presser foot to Pivot position or a floating position over the fabric for easier placement of the fabric.

The presser foot will be lowered automatically when you start sewing. You can also tap the foot control to lower the presser foot.

When you stop with the needle in the down position, the presser foot is automatically lifted to pivot position. This function can be turned off in the SET Menu, see page 41.

FUNCTIONS ON THE TOUCHSCREEN

1. Exclusive SEWING ADVISOR™

The Exclusive SEWING ADVISOR™ feature sets the best stitch, stitch length, stitch width, sewing speed and thread tension for the selected fabric and sewing technique (see page 44).

Touch the Fabric/Techniques tabs and make your selection by touching the fabric/technique you want to use. Touch the arrow in the upper left corner of the TouchScreen to exit the Exclusive SEWING ADVISOR™ feature.

The stitch is shown on the TouchScreen with presser foot, presser foot pressure and needle recommendations.

2. Thread Tension

The best thread tension for the selected stitch and fabric is set automatically. The thread tension can be adjusted for specialty thread, technique or fabric. Touch + to increase the thread tension and – to decrease it.

3. Mirror End to End

Touch to mirror the selected stitch end to end. If touched in Sew Out Mode for stitch programs, the whole stitch program is mirrored. The change is visible on the TouchScreen.

4. Stitch Length/Density

When you select a stitch, your machine automatically sets the best stitch length. The stitch length is visible on the TouchScreen. You can change the stitch length by touching the – or + icons.

If you have selected a buttonhole the TouchScreen will show the density setting instead of the stitch length setting. You will now be able to change the density setting by touching – or +.

If you press Alt (6) when a satin stitch is selected, the TouchScreen will show the density setting. Touch – or + to change the density.

5. Stitch Width/Needle position

The stitch width is set in the same manner as the stitch length. The preset width is visible on the TouchScreen. The width can be adjusted between 0 and 7 mm. Some stitches have a limited stitch width.

If a straight stitch is selected, – and + are used to move the needle to the left or right in 29 positions.

6. Alt (Alternate View)

Touch the Alt icon to show the stitch density instead of the stitch length for some stitches.

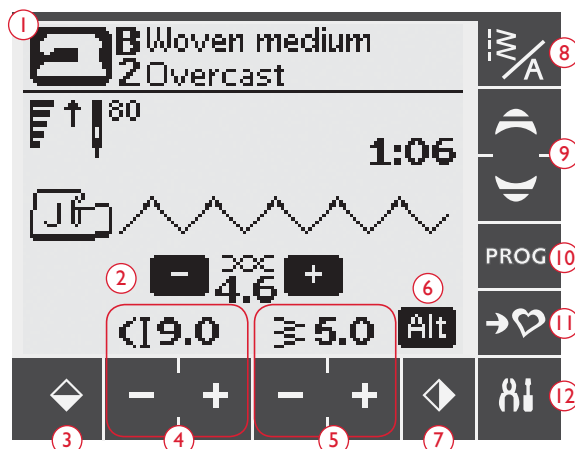

Note: Not all functions are shown at the same time.

7. Mirror Side to Side

Touch to mirror the selected stitch side to side. In straight stitch, with a left needle position, touching this icon will move the needle from the left to the right symmetrically across the center position. If touched in Sew Out Mode for stitch programs, the whole stitch program is mirrored. The change is visible on the TouchScreen.

8. Stitch/Font Menu

Touch the Stitch/Font Menu icon, to open the stitch selection window. There are three tabs, Stitch Menu, My Stitches Menu and Font Menu.

See page 37 for more information on how to select a stitch/font.

9. Navigator Arrows

Use the up/down arrows to scroll up and down in a list of selections.

10. Program Mode

Touch to open the mode for programming. Touch again to exit the program mode.

11. Save to My Stitches

Touch to open the menu where you can save your own personal stitches or stitch programs. Touch again to exit the My Stitches menu.

12. SET Menu

Touch to open the menu for machine settings. Make changes and selections by touching the boxes next to each function. Scroll up and down with the Navigator arrows (9). Touch the SET-Menu icon again to exit the SET Menu.

SEWING MODE (670/690Q)

Sewing Mode is the first view on the TouchScreen after you turn on the machine. Here you will find all the basic information you need to start sewing. This is also the menu where you adjust the settings of your stitch. Straight stitch is selected by default.

1. The fabric and sewing technique selected on the Exclusive SEWING ADVISOR™ feature. Touch to change your selection.
2. The sewing speed is indicated by five levels shown on the TouchScreen. Reduce or increase the speed by pressing SPEED + or SPEED – buttons on the function panel.

Note: On the 670 you will find the speed indication in the lower left corner of your screen.

3. Recommended needle for the selected fabric. An arrow indicates if needle up/down is selected.
4. Recommended presser foot for the selected stitch.
5. Thread tension setting for the selected fabric and stitch. Touch + or – to adjust the thread tension.
6. Reduce or increase the stitch length by touching the Stitch Length – and + icons.
7. The selected stitch, both illustrated and displayed by number.
8. When straight stitch is selected, change the needle position by touching the Stitch Width – and + icons.
9. Recommendation to use stabilizer under your fabric.
10. Indicates that the stitch can be tapered when a Decorative Tapering Stitch is selected. Touch the tapering icon to open a view with tapering settings (690Q).
11. When you select a satin stitch the length and width settings will be shown on the TouchScreen. By touching Alt the density setting will be shown instead of the length setting.
12. Recommendation to use self-adhesive glide plates (see page 5).
13. Reduce or increase the stitch width by touching the Stitch Width – and + icons on the Touch Screen.
14. Indicates that a Stretch 90 needle should be used.
15. Stitch density is shown instead of stitch length when a buttonhole, bartack or darning stitch is selected or when a satin stitch is selected and the Alt icon is touched. Reduce or increase the stitch density by touching the Stitch Length – and + icons.
16. When sewing buttonholes in stretch fabric we recommend to cord the buttonhole for better durability, see page 49.
17. When sewing a manual buttonhole, the darning program, automatic tapering stitches, or tapering stitches (690Q) the reverse icon is shown to indicate that you need to press Reverse when the buttonhole columns, the darning stitch, the automatic tapering stitch or tapering stitch (690Q) are sewn to the desired length.
18. Buttonhole size indication when using the Sensor One-Step Buttonhole Foot. Set the size of the button by touching – or +.

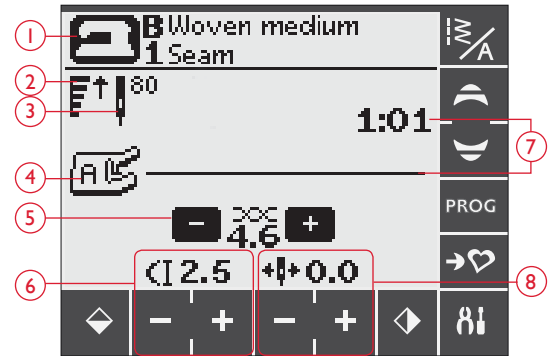

690Q, Normal Sewing Mode, Straight stitch

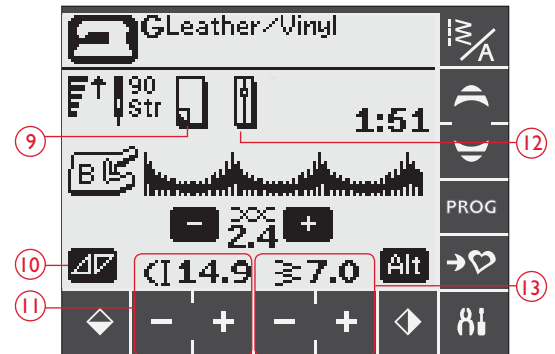

690Q Normal Sewing Mode, Decorative stitch

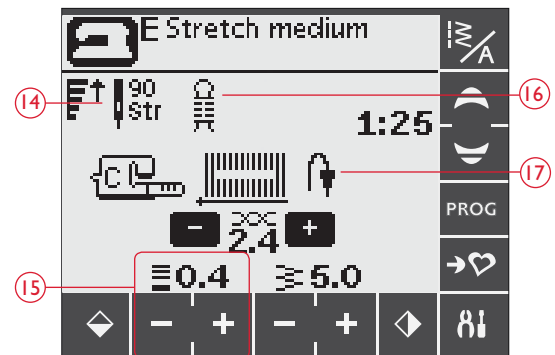

690Q Manual Buttonhole

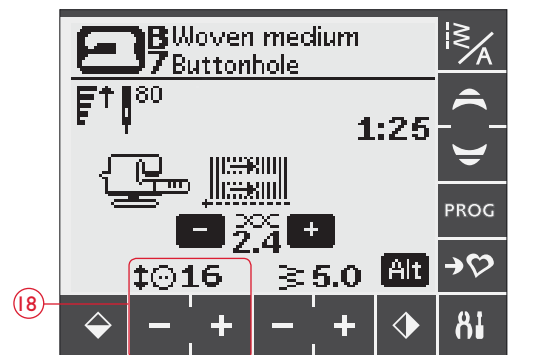

690Q Sensor One-Step Buttonhole

19. The icon for lowering the feed teeth is shown when sewing on buttons is selected.
20. Set the number of stitches to sew on the button by touching the – and + icons.
21. Recommendation to use the multipurpose tool (690Q) when sewing on a button. Place the thin end of the multipurpose tool under the button when sewing on light fabrics. Use the thick end for heavier fabrics.
22. Recommended presser foot pressure (670).

Note: Presser foot pressure is automatically set for 690Q. Go to the SET menu to manually adjust the presser foot pressure.

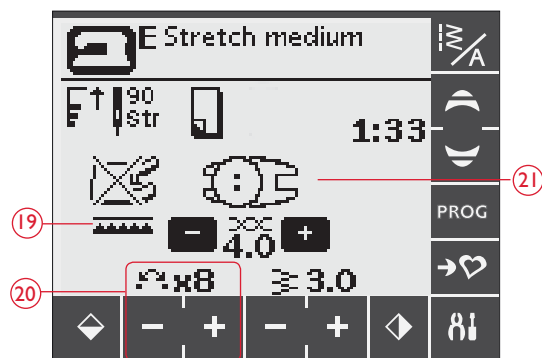

Sewing on button

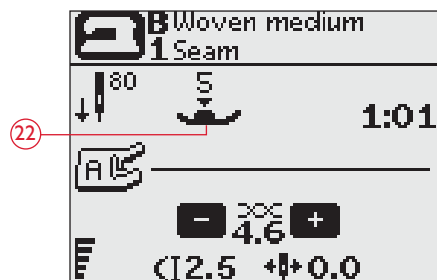

670, Normal Sewing Mode, Straight stitch

SELECTING A STITCH

The stitches available are pictured inside the lid of your machine with the menu numbers on the left and the stitch numbers within the menus across the center.

Touch the Stitch/Font Menu icon (A) to open the stitch/font selection window. There are three tabs to choose from – Stitches, My Stitches and Fonts. The last used tab is active when opening the Stitch/Font menu. Touch the Stitches tab.

Touch to select any of the four menus. The number of the selected menu is shown above the stitch menus.



When you have selected a menu, select the stitch you wish to use by touching the corresponding number on the stitch selection numbers (B). Touch delete (C) if you touch the wrong number. Confirm your selection by touching OK. The stitch selection menu is closed and the stitch is selected.

If you touch OK without making a stitch selection, the machine beeps indicating that you need to make a selection.

If no selection is made, close the stitch/font selection window again by touching the Stitch/Font menu icon.

If the stitch number entered does not exist in the selected menu you will hear a beep.

The selected stitch menu, stitch and stitch number will be visible on the TouchScreen in Sewing Mode. To select another stitch in the same menu just touch the Navigator Arrows to move stitch by stitch in numerical order. You can also open the Stitch/Font menu and make a direct selection by touching the corresponding digits on the screen. To select a stitch in another menu you will first need to change stitch menu and then select the stitch.

SELECTING A FONT

Touch the Stitch/Font Menu icon to open the Stitch/Font selection window. Touch the Font tab. Touch the font you wish to use, the mode for programming letters is automatically opened, see page 38.

There are four fonts to choose from; Block, Brush Line, Cyrillic and Hiragana.

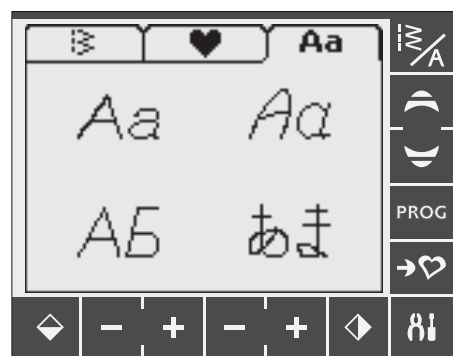

PROGRAMMING (670/690Q)

The Programming function on your machine makes it possible to create stitches with your own personal settings and to combine stitches and letters into stitch programs. You can add up to 20 stitches and letters in the same program. Save your own stitches and programs in My Stitches and recall them any time you like.

All stitches in your sewing machine are programmable except for buttonholes, darning, Automatic Tapering Stitches, button sewing and bartacks.

Create a Stitch Program

1. Touch the PROG icon to open the mode for Programming.
2. The stitch menu which was previously selected will be kept when entering the Programming mode. To change the stitch menu, see page 37.
3. Select the stitch you wish to use. The stitch will appear on the TouchScreen (A).
4. Select the next stitch and it will appear to the right of the last entered stitch.

Note: Two numbers are displayed on the TouchScreen below the stitch program between the selection arrows (B). The first number is the position of the selected stitch in the program. The second number, put in brackets, is the total number of stitches in the program.

The number above the stitch program (C) on the right side of the TouchScreen is the number of the selected stitch.

Add Letters

5. Select a font and the machine will show the upper case alphabet in Programming Mode.
6. Touch to select a letter and to add the letter to the program.
7. To switch to a lower case alphabet or numbers touch the Navigator Arrows (G).

About Programming Letters

Both upper and lower case letters will be stitched with a 7 mm stitch width. If there are letters going below the baseline included in the program (e.g. j, p, y) the height of the uppercase letters will be reduced.

All text to be sewn out on the same project should, if possible, be in the same program to ensure the letters are sewn out in the same height.

Add Stitches or Letters at other Positions

If you wish to add a stitch or letter at another position in the program, move the cursor by touching the arrow icons (D). The stitch or letter will be inserted to the right of the cursor.

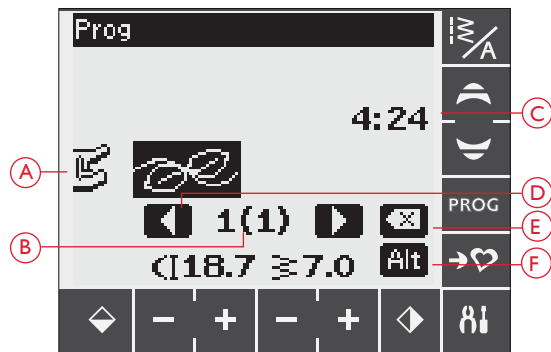

Programming Mode

- A. Stitch program
- B. Position of selected stitch in the program / total number of stitches in program
- C. Selected stitch and stitch menu.
- D. Selection arrows used to step through the program
- E. Delete the selected stitch
- F. Touch Alt to toggle between different settings.

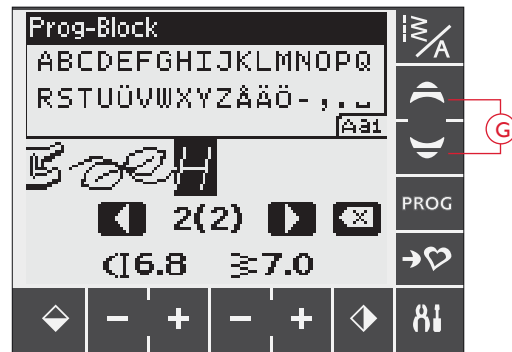

Husqvarna VIKING

“Husqvarna” and “VIKING” have been programmed separately.

Husqvarna VIKING

“Husqvarna” and “VIKING” are in the same program.

Delete Stitches or Letters

To delete a stitch in the program, select the stitch with the cursor by touching the arrow icons and then touch the delete icon (E).

To delete the whole program, you can either touch and hold Delete (long touch) or move the cursor to the left of the first position and touch the delete icon. A pop-up will appear asking you to verify the deletion. Select Yes or No with a touch and confirm with OK.

Add Commands

The commands FIX, STOP and Thread Cut can be added to the program. Each command takes one memory space in the program. To add any of the above functions to your program just press the corresponding function on the Function Panel (see page 34).

Note: If autofix is activated on your machine you do not need to add a FIX at the beginning of the program.



Add commands

Join Two Stitch Programs into One

You can add a previously saved program to a new one in Programming Mode. Touch the Stitch/Font Menu icon, select My Stitches and the program you wish to add. The program will be inserted in Programming Mode to the right of the cursor.

Adjust a Single Stitch or Letter

To adjust the settings of a single stitch in a program you must select the stitch in Programming Mode. You can adjust the stitch width, stitch length, density or mirror the stitch. The settings for the selected stitch are shown on the TouchScreen. Touch Alt to toggle between different settings.



Adjust a single stitch or letter

Adjust the Entire Stitch Program

Adjustments that affect the whole program and not just single stitches, are done in Sewing Mode. Touch the PROG icon to leave Programming Mode and switch to Sewing Mode. In Sewing Mode you can adjust the width and length or mirror the whole program.

There are a few things you need to know when adjusting the stitch program in Sewing Mode:

The adjustments you make to the program in Sewing Mode can be saved to My Stitches. However, these adjustments cannot be brought back to Programming Mode. If you have made adjustments in Sewing Mode and touch the PROG icon to go back to Programming Mode, these adjustments will be cancelled. This will also happen if you load a saved program from My Stitches to Programming Mode.

If you have programmed a STOP, FIX or Thread Cut and mirror the program end to end, the commands will change positions just as the stitches. This might not give the result you intended.

Sew Out the Stitch Program

When you are done with your program touch the My Stitches icon to save it (see below) or, if still in Programming Mode, touch the PROG icon or step on the foot control to switch to Sewing Mode.

Once you are in Sewing Mode and step on the foot control the machine will sew out your stitch program. The program will be sewn continuously if no STOP is programmed. Press the STOP button to sew your stitch program only once.

Step through your sequence by touching the arrow icons (A).



Sewing Mode

MY STITCHES MENU

My Stitches is your own personal menu where you can save and recall your programs or favorite stitches with personal settings.

Model 670 has 8 memories and model 690Q has 12 memories. Each memory has a maximum space of 20 stitches.



My Stitches menu

Save a Stitch or a Program

Touch the My Stitches icon from Programming or Sewing Mode. This will open the My Stitches Menu. Touch to select an empty memory. If the selected memory is not empty, a pop-up message will appear asking if you wish to overwrite the previously saved stitch/program with the new one. Touch "✓" to confirm your selection. Touch "✗" to exit and select another position. Touch the My Stitches icon again to return to Sewing Mode or Programming Mode.

Note: If you want to clear a memory, overwrite by saving an empty program.

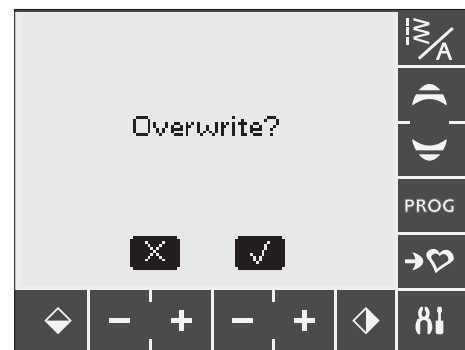

Load a Saved Stitch or Program

To load a saved stitch or program from My Stitches, touch the Stitch/Font Menu icon and touch the My Stitches tab. Scroll up and down to view the memories using the navigator arrows. Touch to select the saved stitch or program. The stitch/program will appear in Sewing Mode ready to be sewn.



Load a saved stitch or program from My Stitches menu

SET MENU

You can change the pre-set machine settings and make manual adjustments to the automatic functions in the SET Menu. Open the menu by touching the SET Menu icon (A). To activate a function, touch to place an X in the box. To cancel the function, touch again to leave the box empty. For some functions, a pop-up window opens for further selection. Touch the SET Menu icon again to close the SET Menu.

Presser foot pressure (690Q)

Use the up/down arrow buttons if you want to adjust the presser foot pressure for the selected stitch. The value can be adjusted between 0 and 8.5 in steps of 0.5. Your manual setting will be cancelled when you select another stitch or turn off the machine.

Note: When you save a stitch or program in My Stitches the setting of the presser foot pressure is also saved.

Pivot height (690Q)

If Free Motion is activated you will be able to set the height of the presser foot pivot position. The pivot position can be raised or lowered in 15 steps by pressing the left/right arrow buttons.

Skipped stitches can occur if your fabric moves up and down with the needle as you are stitching. Lowering the pivot height will reduce the space between the presser foot and the fabric and eliminate the skipped stitches.

Note: Be careful not to reduce the pivot height too much. The fabric must still move freely under the presser foot.

Sensor Foot auto (690Q)

Press the OK button to turn on or off the automatic pivot function for lifting the presser foot for example when stopping with the needle down. The setting will go back to default when the machine is turned off.

Twin Needle

If you are using a twin needle, set the size of the needle to limit the width of all stitches and prevent needle breakage.

Touch the twin needle function to open a pop-up window. Touch the box next to the twin needle size you are using to make your selection.

Your setting will be saved also when the machine is turned off. A pop-up message reminds you of the setting when you turn on the machine. Close the pop-up message by pressing OK.

Note: You cannot set the twin needle size if the Stitch Width Safety is on, or turn on the Stitch Width Safety if the machine is set for twin needle.

Stitch Width Safety

Touch to turn on the Stitch Width Safety when using a straight stitch needle plate or a straight stitch presser foot (optional accessories).

The stitch width will be limited to zero for all stitches to prevent damage to the needle, presser foot and needle plate. This setting is saved when the machine is turned off. A pop-up message reminds you of the setting when you turn on the machine.

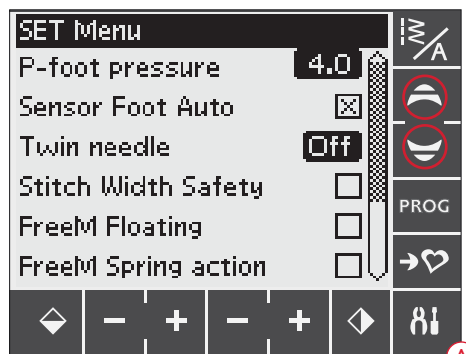

Free Motion Floating* (690Q)

To sew in free motion with the included Embroidery/Darning Foot R or with any optional Free Motion Floating presser foot, set the machine in Free Motion Floating Mode. In Sewing Mode the drop feed teeth recommendation will be activated. The setting remains when the machine is turned off. A pop-up reminds you of the setting when you turn on the machine. Close the pop-up message by pressing OK.

Note: You cannot set the machine in Free Motion Floating Mode if Free Motion Spring Action is activated or vice versa.

Free Motion Spring Action** (690Q)

If you are using any of the optional Free Motion Spring Action presser feet, you need to set the machine in Free Motion Spring Action Mode. In Sewing Mode the drop feed teeth recommendation will be activated. The setting remains when the machine is turned off. A pop-up message reminds you of the setting when you turn on the machine. Close the pop-up message by pressing OK.

*Free Motion Floating

When you are sewing free motion at low speed the foot will raise and lower with each stitch to hold the fabric on the stitch plate while the stitch is being formed. When sewing in high speed, the foot floats over the fabric while sewing. The feed teeth must be lowered and the fabric is moved manually. All stitches can be sewn in Free Motion Mode.

**Free Motion Spring Action

The Free Motion Spring Action presser feet follows the up and down movement of the needle with help of the spring and the arm on the presser foot. The feed teeth must be lowered and the fabric is moved manually. It is recommended to turn on the Stitch Width Safety for the presser feet that are only intended for straight stitch sewing.

FIX Auto

Touch to turn on or off the automatic FIX function in the beginning of each stitch. The settings is saved when turning off the machine.

Thread Cutter Auto

The Thread Cutter will automatically cut the threads after a buttonhole or eyelet is sewn. Touch to turn off the cut function. The setting is saved even if the machine is turned off.

Audible Alarm

Turns on or off all alarm sounds of the machine. Default setting is on. The setting is saved even if the machine is turned off.

Contrast

Touch to open a window to adjust the contrast of the TouchScreen. Confirm the adjustment by touching OK

The value can be set between -20 to 20 in steps of 1. The setting is stored even when the machine is turned off.

Language

Touch to open a pop-up window with language selections that will change the language of all text in your machine. Scroll up and down by touching the navigator arrows. Touch to select language and confirm by touching OK.

The language setting is saved even if the machine is turned off.

Buttonhole Balance

If the Sensor One-Step Buttonhole Foot is not connected or if you select stitch 1:28, the columns in the buttonhole stitch will be sewn in different directions. On some fabrics this may cause the columns to appear with different density.

Touch to open a window to adjust the buttonhole balance. The changes only affect the selected stitch. If another stitch is selected or the same stitch is selected again, the value is reset to the default value.

Software Version

The software version currently loaded for the sewing machine is displayed.

Calibrate TouchScreen

If you touch a function or menu on the TouchScreen but it does not respond, or if the function next to it is activated instead, the screen has to be calibrated.

You only need to calibrate the TouchScreen if there is a precision problem when touching the screen.

Touch Calibrate TouchScreen to open a view for calibration. Follow the instructions on the screen to calibrate.

Note: When calibrating the screen, be sure to touch the calibration areas only, as instructed. If other areas are touched, the screen can be miscalibrated.

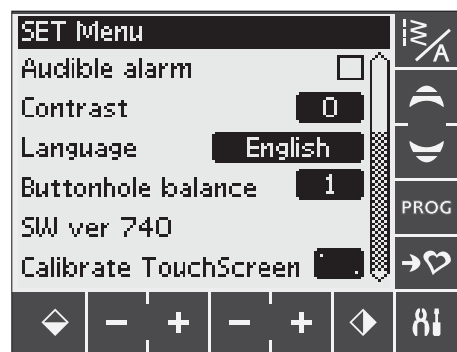
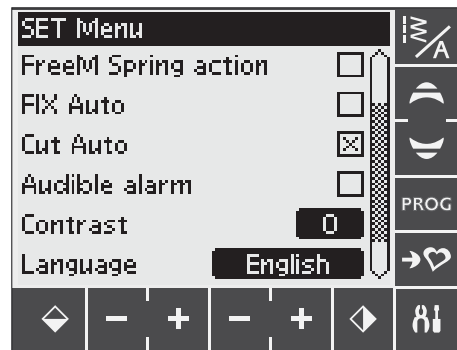

SEWING



EXCLUSIVE SEWING ADVISOR™

Your sewing machine has the Exclusive HUSQVARNA VIKING® SEWING ADVISOR™ feature. The Exclusive SEWING ADVISOR™ feature automatically sets the best stitch, stitch length, stitch width, sewing speed and thread tension (670/690Q) for your project. The stitch is displayed on the GraphicDisplay/TouchScreen with presser foot, presser foot pressure, thread tension (650), and needle recommendations.

Select desired fabric type and sewing technique (see explanation on page 45).

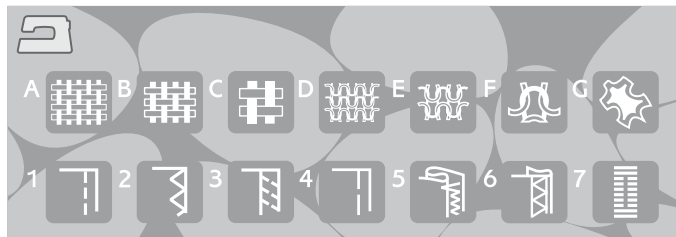

650

Exclusive SEWING ADVISOR™ on 650

Press the symbols for the fabric you are using and the sewing technique you wish to sew.

Exclusive SEWING ADVISOR™ on 670/690Q

Touch the Exclusive SEWING ADVISOR™ icon to open the Exclusive SEWING ADVISOR™ feature. Touch the Fabric/Techniques tabs and make your selection by touching the fabric/technique you want to use. Touch the arrow in the upper left corner of the TouchScreen to exit the Exclusive SEWING ADVISOR™ feature.



670/690Q

Woven or Stretch (Knit)

The difference between woven and stretch (knit) fabric is the way the threads are put together. Woven fabrics are made of two thread systems, warp lengthwise and weft crosswise that intersect at right angles. A knit fabric is made of one thread system with interlaced stitches. A knit fabric usually has stretch.

As a general rule, enter Woven for stable fabrics that have no stretch and Stretch for fabrics that have stretch.

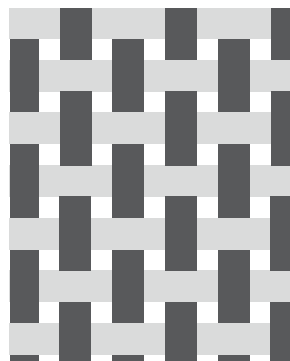

Woven fabric

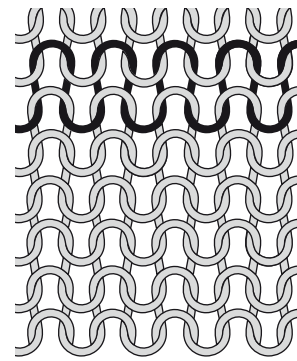

Stretch (knit) fabric

Leather/Vinyl

Leather is animal skin with the coat (fur) removed. Leather can be smooth or sueded and has some give.

Vinyl is a synthetic material which often has a woven wrong side. Vinyl can be smooth or patterned and some vinyl has give.

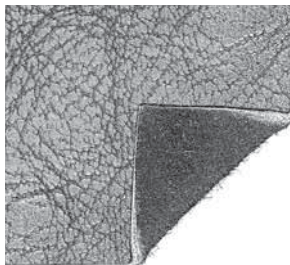

Leather

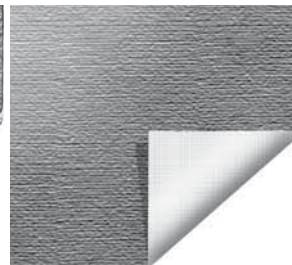

Vinyl

Fabric Selection



WOVEN LIGHT: chiffon, organza, batiste, silk, wool challis, etc.



WOVEN MEDIUM: calico, quilting fabrics, wool crepe, broadcloth, etc.



WOVEN HEAVY: denim, wool suiting and coating, canvas, terrycloth, quilt layers with batting, etc.



STRETCH LIGHT: charmeuse, tricot, single knit jerseys, etc.



STRETCH MEDIUM: double knit, velour, swimwear, etc.



STRETCH HEAVY: sweater knits, fleece, etc.



LEATHER AND VINYL: suede, leather, vinyl and synthetic leather.

When selected, the Non-Stick Glide Foot H (optional accessory, part number 4127961-45) is recommended for utility sewing. For decorative stitches and buttonholes, the Exclusive SEWING ADVISOR™ feature recommends the use of self-adhesive glide soles (see page 5).

SEAM

A seam sews two pieces of fabric together with a seam allowance that usually will be pressed open. In most cases, edges of the seam allowance are finished with an overcast stitch before sewing the seam.

Seams on stretch fabric must stretch with the fabric. The Stretch Stitch makes a stretchy seam that is suitable for sewing together pieces of light stretch fabric.

OVERCAST

The three-step zigzag is up to 7 mm wide and suitable for all types of fabrics. Use this stitch for overcasting, butting two edges together to join them, mending tears and other special finishing.

Use Edging Foot J when overcasting.

Sewing Technique



SEAM: sews two pieces of fabric together.



OVERCAST: finishes fabric edges to prevent them from fraying and to help them lay flat.



SEAM/OVERCAST: sews the seam and overcasts the edge all at one time.



BASTE: a temporary stitching for fitting garments, gathering and marking. The Exclusive SEWING ADVISOR™ feature automatically sets a long stitch length and reduces the tension (670/690Q) so the threads are easy to remove or to pull for gathering.



BLIND HEM: creates an invisible hem on garments. Not recommended for light weight fabric or for leather/vinyl.



HEM: selects the best visible or top stitch hem for your fabric type and weight.



BUTTONHOLE: the best buttonhole for your fabric is selected.

Note: If an unsuitable combination is selected (for example woven light – blind hem), the machine beeps and the technique remains unselected.

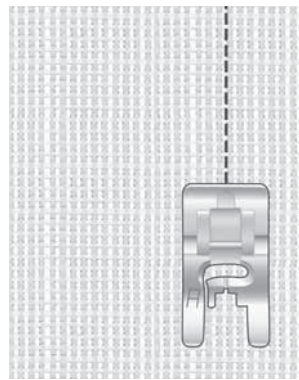

Woven Medium and Seam



Stretch Light and Seam

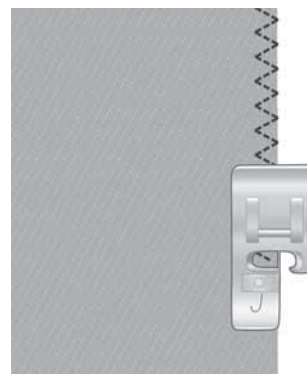

Any fabric type and Overcast

SEAM AND OVERCAST

The Seam/Overcast stitch sews the seam and overcasts the edge all at one time. There are a number of different Seam/Overcast stitches on your sewing machine to give the best result for your chosen fabric.

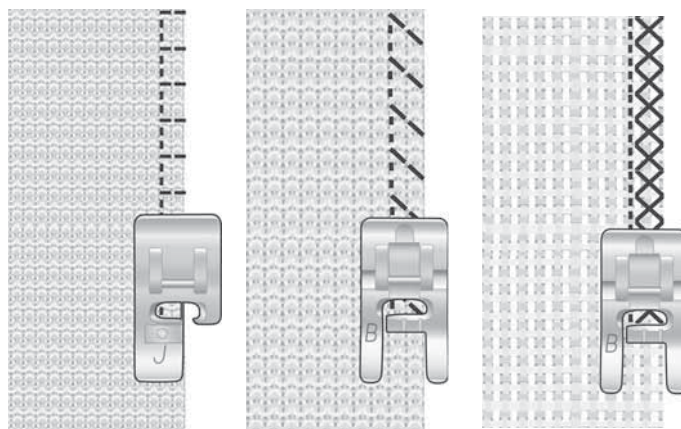

Woven Medium and Seam/Overcast

Stretch Heavy and Seam/Overcast

Woven Heavy and Seam/Overcast

BASTE

Basting is temporary stitching for fitting garments, gathering and marking.

The Exclusive SEWING ADVISOR™ feature automatically sets a long stitch length and reduces the tension so the threads are easy to remove or to pull for gathering.

On your 650, reduce the thread tension according to the recommendations on the GraphicDisplay.

Place the fabrics right sides together. Put the fabric in position under the presser foot with 5/8" (15 mm) seam allowance. Stitch along seam line.

To remove stitching pull the bobbin thread.



Any fabric type and Baste

BLIND HEM

The blind hem creates an invisible hem on a garment. There are two types of blind hem; one is recommended for medium to heavy stretch fabric, the other for medium to heavy woven fabric.

Fold the fabric as illustrated. Make sure the folded edge of the fabric follows the inside of the right "toe" of Blind Hem Foot D.

The left swing of the needle should just catch the edge of the folded fabric.

If necessary, adjust the stitch width as needed to barely "catch" the fold.

Note: The blind hem technique is not recommended for light weight fabric or leather/vinyl. If you select the blind hem and light woven, light stretch or leather and vinyl you will hear a beep and the technique will be unselected.

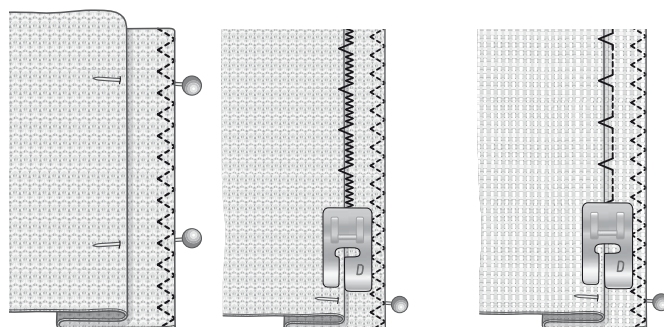

Stretch Medium/Heavy and Blind Hem

Woven Medium/Heavy and Blind Hem

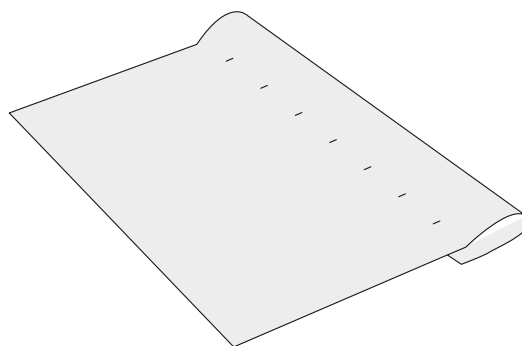

HEM

The Hem technique on your Exclusive SEWING ADVISOR™ feature will select the visible or topstitch hem that is best for your fabric weight and type. For woven fabric and leather and vinyl, a straight stitch is selected. For stretch fabrics, stitches that stretch are selected.

Jeans Hem

When sewing over seams in extra heavy fabric or a jeans hem, the presser foot may tip as it rides over the seam. Use the multipurpose tool to balance the height of the presser foot as you sew.

Press Needle Up/Down to select the needle down position. Begin sewing the bottom hem at or near the center back. As you near the side seam, stop sewing. Your machine stops with the needle in the fabric. Raise the presser foot and insert the multipurpose tool from behind.

Both sides of the multipurpose tool are raised. Use the side which corresponds closest to the thickness of the seam. Lower the presser foot and continue sewing slowly over the thick seam.

Stop sewing again just in front of the seam with the needle in the fabric. Remove the multipurpose tool and re-insert it under the presser foot from the front.

Sew a few stitches until the whole presser foot has passed the seam and is resting on the multipurpose tool. Stop sewing once again. The needle is in the fabric. Raise the presser foot and remove the multipurpose tool. Continue sewing the hem.

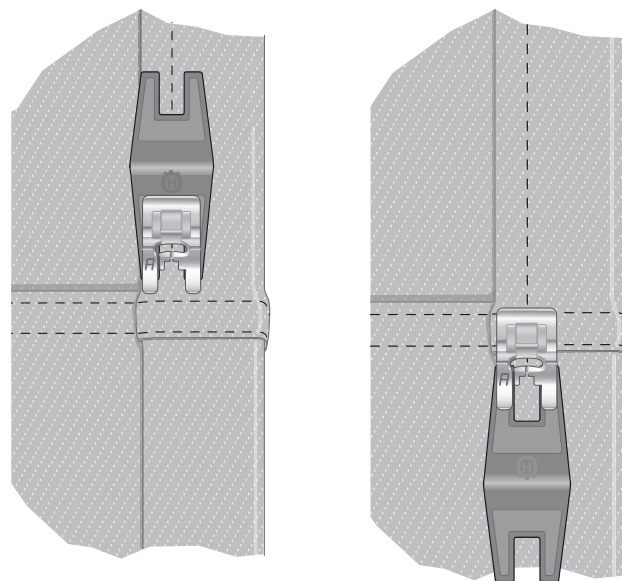

Jeans Hem – Woven Heavy and Hem

Tip: When sewing in heavy denim, use a special Denim Needle designed to penetrate tightly woven fabrics. These are available as optional accessories, please consult the HUSQVARNA VIKING® Accessory User's Guide, available at www.husqvarnaviking.com.

Stretch Hem

Select Stretch Medium and Hem and the Exclusive SEWING ADVISOR™ feature selects a flatlock stitch. Follow other recommendations given on the GraphicDisplay/TouchScreen.

Fold a hem to the wrong side and stitch with flatlock stitch from the right side. Trim away excess fabric.

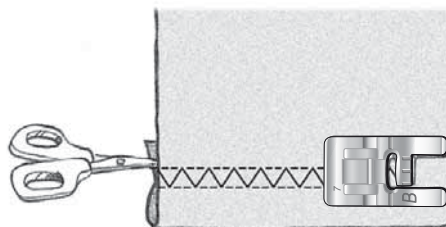

Stretch Medium and Hem

Flatlock stitch to hem stretch fabric and for belt loops.

SEWING BUTTONHOLES

The buttonholes in your sewing machine are specially adjusted for different kinds of fabric and garments. Learn about different buttonholes and when to use them by studying the stitch table in the overview chapter.

The Exclusive SEWING ADVISOR™ feature will select the best buttonhole and stitch settings for your fabric. Fabric should be interfaced and/or stabilized where buttonholes are to be sewn.

Automatic One-Step Sensor Buttonholes

When you select a buttonhole stitch with the Sensor One-Step Buttonhole Foot connected, you will be able to set the size of the button on the GraphicDisplay/TouchScreen. Set the size of the button by pressing the (up and down) Navigator Arrows (A) (650) or by touching – or + (B) (670/690Q). When sewing, your sewing machine automatically sews the buttonhole long enough to fit the selected button size. Because the Sensor One-Step Buttonhole Foot measures as it sews, every buttonhole will be the same size.

Note: The buttonhole size will vary with the thickness and style of your button. Always stitch a sample buttonhole on scrap fabric first.

1. Attach the Sensor One-Step Buttonhole Foot.
2. Plug the cord into the socket above the needle area.
3. Measure the button diameter using the button measuring chart on the front of the machine.
4. Set the button size on the GraphicDisplay/TouchScreen. The size can be set between 0-50 mm.
5. Place the fabric and stabilizer under the Sensor One-Step Buttonhole Foot. The measurement wheel can be raised by lifting it, which makes it easier to place the fabric under the presser foot. Use the markings on the left toe of the Sensor One-Step Buttonhole Foot to position the garment edge. Place the edge of the garment at the middle mark to have 5/8" (15 mm) from the edge to the buttonhole.
6. Before sewing, line up the white area on the side of the red wheel with the white marking line on the foot.
7. Lower the presser foot. Step on the foot control. A straight stitch is sewn away from you stabilizing the left buttonhole column, then the satin column is sewn toward you. This is repeated for the right column. The bartacks are also sewn automatically. The arrows on the GraphicDisplay/TouchScreen will show when each part of the buttonhole is sewn and in what direction. Keep the foot control depressed until the buttonhole is finished. The machine will stop automatically when the buttonhole is completed.

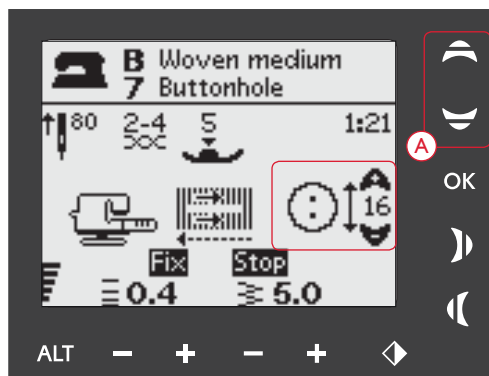

650: Set the size of the button by using the up and down Navigator Arrows (A).

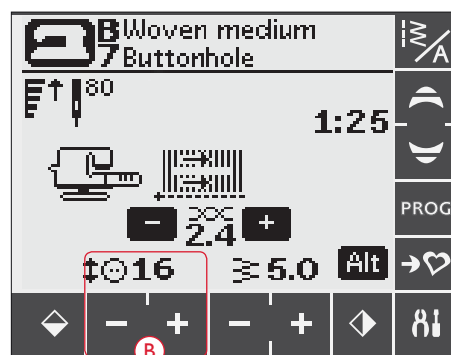

670/690Q: Set the size of the button by touching the + and – icons (B).

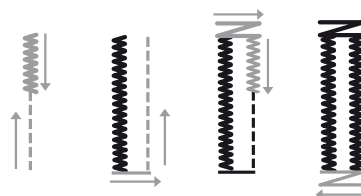
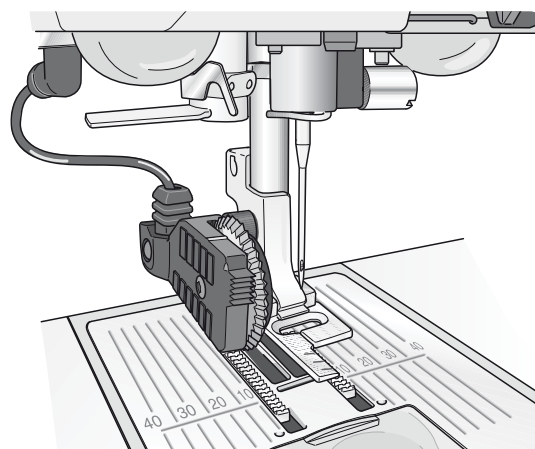

Manual Buttonholes

A buttonhole can also be sewn step by step without the Sensor One-Step Buttonhole Foot connected. Use Reverse to set the length of the buttonhole.

1. Snap on Presser Foot C.
2. Place the fabric and stabilizer under the presser foot. Use the markings on the left toe of the buttonhole foot to position the garment edge. Place the edge of the garment at the middle mark to have 5/8" (15 mm) from the edge to the buttonhole. Lower the presser foot.
3. Begin sewing the buttonhole. The sewing machine will sew the left column in reverse. A reverse icon (A) is shown on the GraphicDisplay/TouchScreen indicating that you need to press Reverse to step to the next part of the stitch. When the buttonhole has reached the desired length, press Reverse. Your sewing machine will bartack the end and stitch the right side.
4. Sew to the starting mark and press Reverse to sew the second bartack. Keep the foot control depressed until the buttonhole is finished. The machine will stop automatically when the buttonhole is complete.
5. Repeat the buttonhole by touching the STOP button.

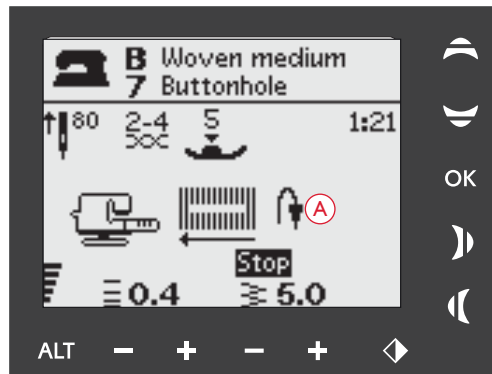
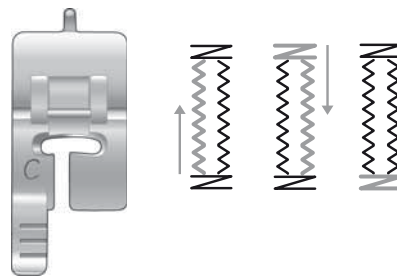

Manual buttonhole, 650

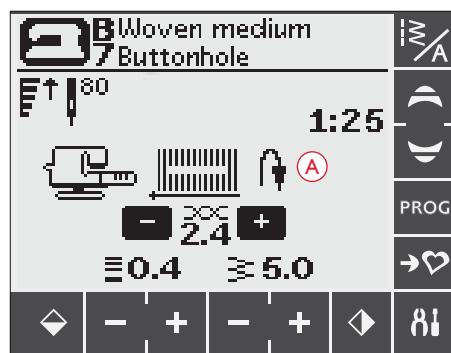

Manual buttonhole, 670/690Q

Corded Buttonhole (Stretch fabrics)

When sewing buttonholes in stretch fabrics we recommend cording the buttonhole to increase the stability and to keep the buttonhole from stretching out.

1. Loop a piece of heavy thread or gimp cord over the finger on the back of Presser Foot C.
2. Stitch a buttonhole. Let the satin buttonhole columns stitch over the cord.
3. Stop sewing before the last bartack of the buttonhole is sewn. Lift the cord off the finger and pull out the slack.
4. Cross the cord in front of the needle and stitch the bartack of the buttonhole over the cord.

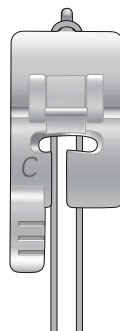

SEWING ON BUTTONS

Sew buttons, snaps, hooks and eyes quickly with your sewing machine.

Select the fabric you are using and the stitch for sewing on buttons 1:29 (650) / 1:33 (670/690Q).

1. Snap off the presser foot and lower the feed teeth.
2. Place the fabric, multipurpose tool (optional accessory 650/670, part number 4131056-01) and button under the ankle with the holes in the button lined up with the swing of the needle. Check the swing of the needle by pressing the mirror side to side button to be sure the needle will not hit the button. Bring the needle down into the holes of the button with the hand wheel to verify.

Tip: When using the multipurpose tool, the button is stitched to the fabric leaving a shank. If stitching without the multipurpose tool the button is stitched to the fabric without distance.

Note: The recommended width of 3.0 is set for most buttons. If you sew a tiny button or a very large coat button, decrease (-) or increase (+) the stitch width until the swing of the needle sews in the holes of the button.

3. The default number of stitches to sew on the button is set to 8 stitches (A). By pressing the up and down Navigator Arrows (650) or by touching + or - (670/690Q), the number of stitches is changed. Six to eight stitches is standard.
4. Press the foot control. The sewing machine will sew the number of stitches set on the display and then tie off and stop.
5. Raise feed teeth when button sewing is completed.

Tip: Place the thin end of the multipurpose tool (optional accessory 650/670, part number 4131056-01) under the button when sewing on light fabrics. Use the thick end for heavier fabrics. Hold in place on the fabric with transparent tape.

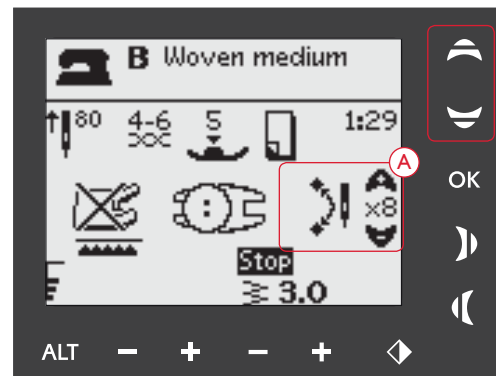
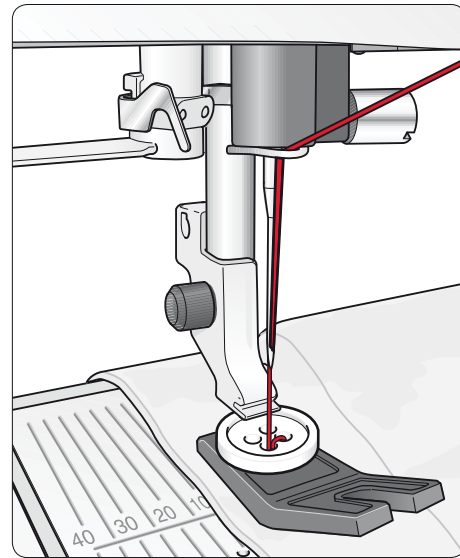

Button Sewing, 650



Button Sewing, 670/690Q

SEWING ZIPPERS

The Zipper Foot E can be snapped on either the right or the left of the needle, making it easy to sew both sides of the zipper. To sew the other side of the zipper, reposition the Zipper Foot.

Move the needle position to the far left or far right to stitch close to the zipper teeth or cording.

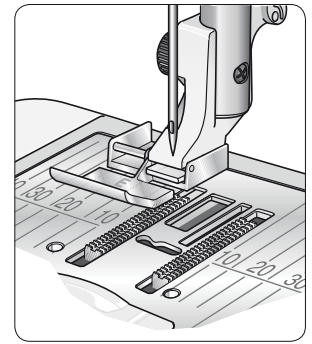
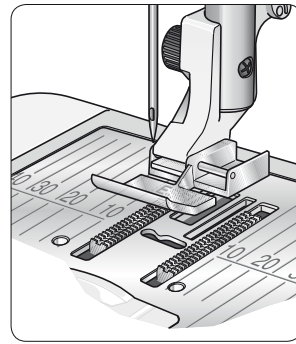

Center Zipper

1. Sew the two fabrics right sides together along the 5/8" (15mm) seam line, stopping at the notch for the zipper placement.
2. Baste the remaining seam where the zipper will be placed. Press the seam open. Place the zipper with its right side to the pressed open seam allowance, placing the zipper stop at the notch. Pin the zipper on the right side so it stays in place (A).
3. Select straight stitch and move the needle position to the left. Snap on the Zipper Foot E so the needle is on the left side of the foot. Place fabric under the foot right side up with the zipper foot on the right side of the zipper.
4. Begin stitching across the bottom, turn the fabric and stitch the right side of the zipper to the top (B).
5. To avoid fabric shifting, sew the left side of the zipper in the same direction. Snap on the Zipper Foot E so the needle is on the right side of the foot. Move the needle position to the right.
6. Begin stitching across the bottom, turn the fabric and stitch the left side of the zipper sewing from the bottom to the top (C).
7. Remove the basting stitches.

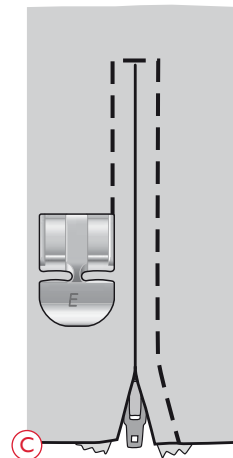
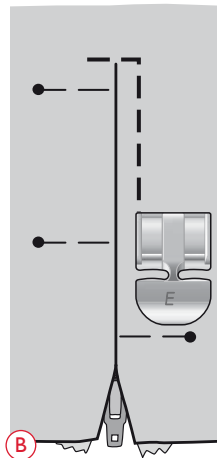
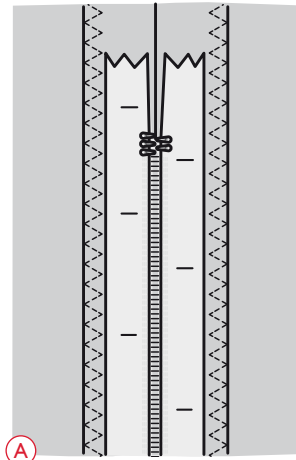

Note: To adjust the position of the stitching line, adjust the needle position with the stitch width buttons.

DARNING AND MENDING

Darning a small hole or a tear before it becomes larger can save a garment. Choose a fine thread in a color as close to your garment as possible.

1. Place the fabric in position under the presser foot.
2. Start sewing above the hole and over it.
3. Once over the hole, press Reverse. Continue sewing. The machine sews back and forth across the hole 14 times and then stops.
4. To repeat the stitch with the same size, press STOP. Reposition your fabric, then step on the foot control to sew again. The stitch will now repeat the same size darning square. The machine will stop automatically when the stitch is completed.

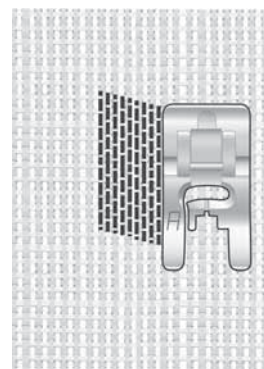

*Select fabric type and stitch
1:19 (650),
1:22 (670/690Q)*

BARTACK (MANUAL)

Secure elastic ends, drapery pleats, belt loops, and pocket corners with the same look as ready-to-wear.

1. Place fabric under the presser foot. Lower the presser foot and press on the foot control to start sewing. Your machine will sew a straight stitch until you touch Reverse.
2. Your machine will then sew in reverse until you touch reverse again.
3. Your machine will then sew a zigzag, covering the straight stitches.
4. Touch Reverse to automatically tie off.

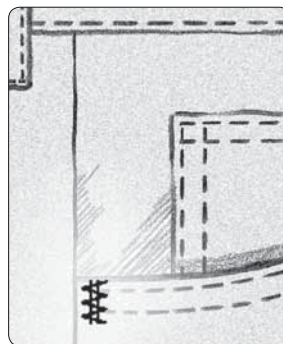

Woven Heavy and stitch 1:20 (650), 1:23 (670/690Q)

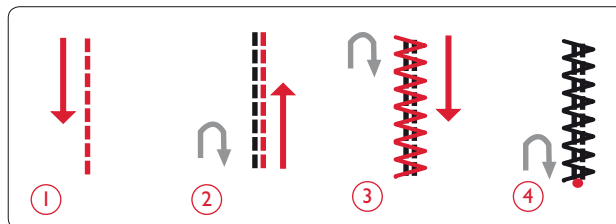

Decorative Tapering Stitches (690Q)

The Decorative Tapering Stitches can be used to taper the stitch to form corners and points. The Decorative Tapering Stitches are marked with a blue color in the Stitch panel in the lid.

1. Select a Decorative Tapering Stitch.
2. Press the taperings icon to open the tapering window. The tapering window has two different tabs; Tapering beginning and Tapering end. Touch the angle that you want to use in each tab. Press the arrow in the top left corner to return to Sewing mode.



3. Icons will appear on the TouchScreen to show you that the beginning and/or end tapering are activated.

Note: Its important to adjust your settings before starting to sew.

4. Place the fabric under the presser foot.
5. Start sewing. If tapering is activated at both the beginning and at the end, the machine will sew the tapered point and then continue with the stitch in the selected stitch width. A reverse icon is shown on the GraphicDisplay.
6. When the stitch is the length as desired, press the Reverse button to start the end tapering. When the tapering is completed the machine stops automatically.

Tip: To repeat a tapering stitch of the same size, program the desired number of stitches, exit programming and then add tapering at the beginning and/or end.

Note: The Automatic Tapering Stitches (1:37 and 1:38 670/690Q) will automatically taper the stitch. Follow step 4-5 to sew these stitches. To repeat these two stitches press the STOP button.

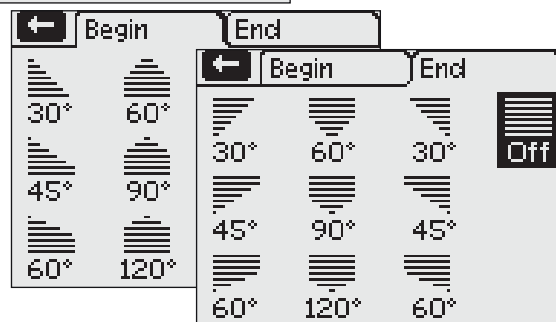

The stitch can be tapered.



Tapering beginning activated.



Tapering beginning and end activated.

QUILTING

A quilt usually consists of three layers, two layers of fabric with a layer of batting sandwiched between. To sew three layers together, you have a wide variety of stitches and techniques to choose from. When the quilting is finished simply bind the edges or make it into cushions, wearable art or other smaller projects.

Crazy Quilt Stitching

Embellish your quilt with decorative stitches. The stitches can be sewn in a coordinating or contrasting color. Decorative threads like rayon embroidery or heavy cotton threads are sometimes used. Find stitches perfect for crazy quilting on Stitch Menu 2.

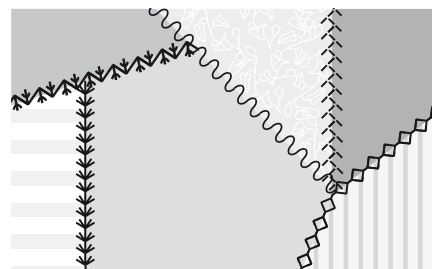

Hand-look Quilting

Simulate the look of handmade quilting with invisible thread and the Hand-look Quilting stitch (2:2). Thread the needle with clear invisible thread and the bobbin with a color of thread that coordinates with your fabric.

To get the accurate hand stitched look it is important that the stitch is sewn using a high thread tension. Make sure to set the tension according to the recommendations on the GraphicDisplay (650) (on the 670/690Q, the thread tension is set automatically).

Stitch along one of the seams of your project. The handlook effect is created as the bobbin thread is pulled up to the top of the quilt.

Note: When sewing with the hand-look quilting stitch, the result depends on what fabric, batting and thread you are using. Be sure to try the stitch on a sample first. Adjust the thread tension as needed for your project.

Free Motion Quilting

Free-motion quilting not only keeps the top, batting and backing together, but it also adds texture and interest to your quilt.

There are several techniques to use when free motion quilting. Decorate your quilt as you like, only your imagination sets the limits. Two free motion techniques are stippling and circles.

Free motion stippling is typically a tightly and evenly spaced meandering stitch line. When stippling, draw squiggles with the needle as you sew. Another technique is to make circular motions on the fabric as you sew creating a stone shaped pattern.

Free-motion quilting is done with the feed teeth lowered. You move the fabric manually to determine the stitch length (see page 41).

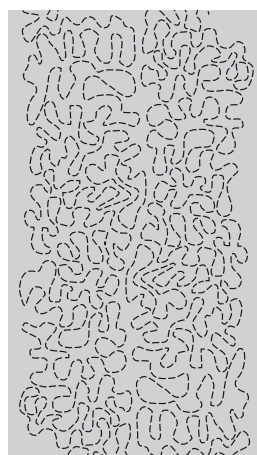

Free motion stippling

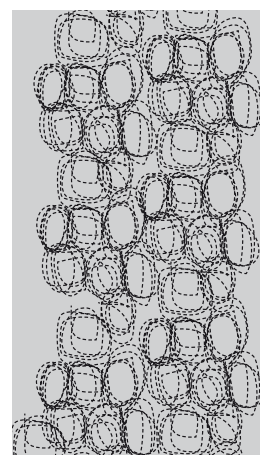











Free motion with circular motions

Tip! Practice free motion sewing on scraps of the fabric and batting from your quilt. It is important to move your hands at the same speed as the needle to prevent stitches that are too long or too short. Maintaining a consistent speed while free-motion sewing will also help keep stitches even.

SPECIALITY STITCHES

The special sewing technique stitches are stitches that are sewn with special presser feet (optional) to create exciting effects. These stitches are 4:37-4:40 (650) / 4:42-4:50 (670) / 4:42-4:52 (690Q). When selected this is indicated by the optional presser foot icon (A) on the GraphicDisplay/TouchScreen. The special sewing technique stitches are pictured and described below.

Stitch	Stitch Number			Presser Foot	Technique	
	690Q	670	650			
	4:42	4:42	4:37	Specialty Candlewicking Foot (part number: 4131623-45)	Creates a “French Knot” stitch. The presser foot has a deep tunnel on the underside to feed over the built-up stitches.	
		4:43	4:43			(A) –
		4:44	4:44			–
	4:45	4:45	4:38	Left Edge Topstitch Foot (part number 4127842-45)	Use these stitches together with the foot to give beautiful embellishment/topstitch to your projects. The underside of the foot is designed to glide along the folded edge.	
		4:46	4:46			(A) –
	4:47	4:47	4:39	Three Hole Yarn Foot (part number: 4131870-45)	Decorate your projects with different types of decorative cords or yarn. This foot easily guides the yarn through the opening in the front of the foot. The yarn will be stitched over creating a beautiful braid embellishment.	
		4:48	4:48			(A) –
	4:49	4:49	–	Join and Fold Edging Foot (part number 4132488-45)	Use this foot together with different types of edgings such as lace, embroidered trims or various fabrics. Combined with these stitches it will create an exciting effect.	
		4:50	4:50			(A) 4:40
	4:51	-	-	Twin gimping foot with guide (Part Number 920 302-096)	Use the Twin Gimping Foot with one single needle to create three-dimensional satin stitches.	
	4:52	-	-	Twin gimping foot with guide (Part Number 920 302-096)	Use the Twin Gimping Foot and a 1.6 twin needle to create three-dimensional satin stitches. Two gimp threads are guided by the foot as the stitch is sewn.	

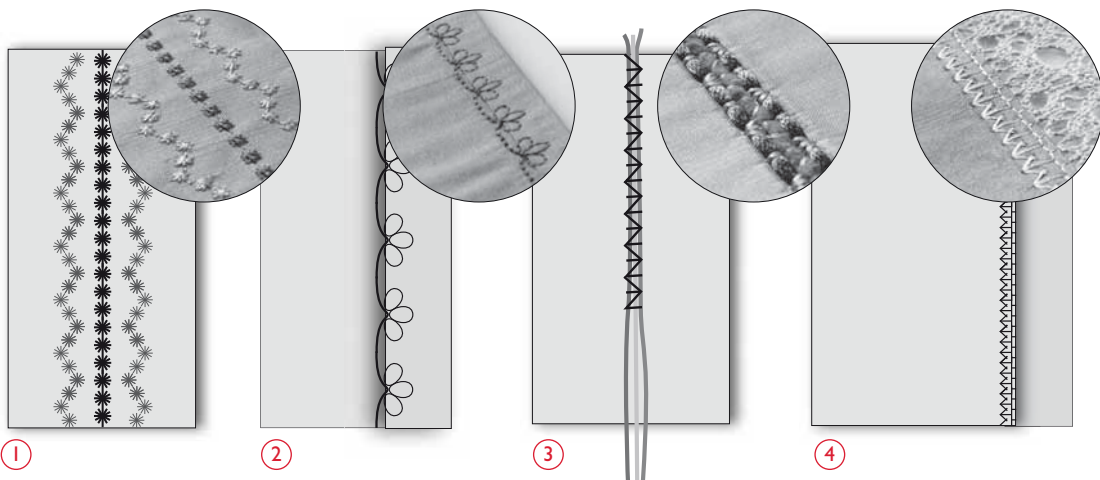

POP-UP MESSAGES



POP-UP MESSAGES

Bobbin Winding On

This pop-up message appears when the bobbin winding spindle is pushed to the right and bobbin winding is activated.

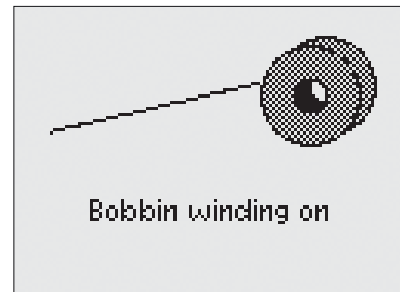

Presser foot too high (690Q)

Your machine will not sew if there is too much fabric under the presser foot. Press the OK button, or tap the foot control to close the pop-up message.

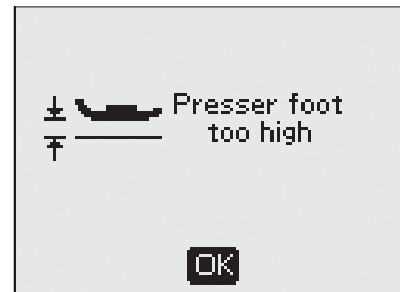

Machine Set for Twin Needle

When you have set the machine for twin needle in the SET Menu, a pop-up message is shown to remind you of the setting when you turn on your machine. Close the pop-up message with OK.

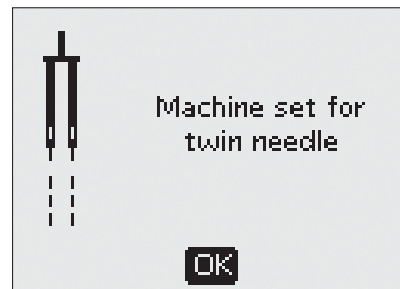

Stitch Width Limited for Twin Needle

This message is shown when the machine is set for twin needle and you try to adjust the stitch width to wider than possible with the twin needle. Close the pop-up message with OK.

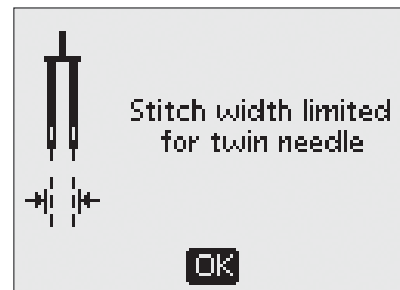

This Stitch Cannot be Sewn with Twin Needle

This pop-up message appears when the machine is set for twin needle and you select a stitch that cannot be sewn with twin needle. Close the pop-up message with OK.

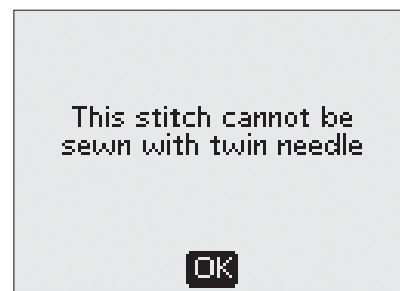

Machine Set for Straight Stitch

This message is shown when the stitch width safety is on and you turn on the machine, select a wide stitch or adjust the stitch width. Close the pop-up message with OK.

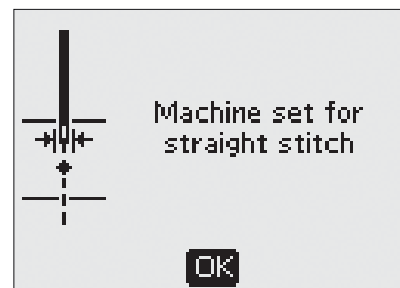

Main Motor Overload

If you are sewing on very heavy fabric or if the machine is blocked when sewing, the main motor can get overloaded. The pop-up message will close when the main motor and power supply is secure.



Sensor One-Step Buttonhole Foot Line Up - "Adjust White Area to White Line"

When you insert the fabric for sewing a buttonhole, the wheel of the Sensor One-Step Buttonhole Foot might move. A pop-up message prompts you to line up the white area with the white line. Line up the white areas and close the pop-up message with OK.

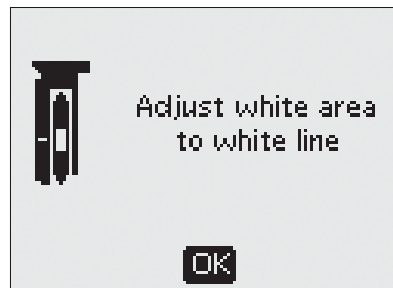

Sensor One-Step Buttonhole Foot Connected

The Sensor One-Step Buttonhole Foot can only be used for the buttonhole stitches recommended for the foot. If the Sensor One-Step Buttonhole Foot is connected and you select a stitch that is not possible to sew with the foot, this message will appear when you start to sew. Remove the foot or select a buttonhole that can be sewn with the Sensor One-Step Buttonhole Foot. Close the pop-up message with OK.

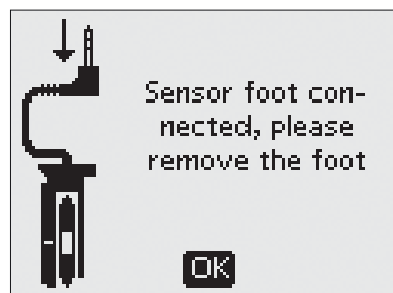

Machine set for free motion sewing (690Q)

This message is shown when the machine is set to Free Motion Floating or Free Motion Spring Action and you turn on the machine. Close the pop-up message by pressing the OK button.



Restart the Buttonhole?

If you are sewing a buttonhole and stop to adjust the length settings you will get this question once you start sewing again. If you select "✓", the machine will restart and sew the buttonhole from the beginning with the new settings. If you select "✗", the change will be cancelled and the machine will continue sewing the rest of the buttonhole with the previous settings. On the 650, use the left/right Navigator arrows to select "✓" or "✗" and confirm with OK. On the 670/690Q, touch "✓" or "✗" to make your selection.



The Stitch Cannot be Programmed

This message is shown if you try to program or add a buttonhole, bartack or Automatic Tapering stitches (670/690Q) or the sew on button stitch to a program. All stitches in your sewing machine are programmable except for these. Close the pop-up message with OK.



The Stitch Cannot be Saved

This message is shown if you try to save a buttonhole, bartack, darning or Automatic Tapering stitches or the sew on button stitch to My Stitches. All stitches in your machine can be saved in My Stitches except for these. Close the pop-up message with OK.



Program too Long to Add More Stitches

If you try to add more than 20 stitches or letters in the same program this message is shown. Close the pop-up message with OK.

Note: If you add a FIX, STOP or a Thread Cut (670/690Q) to the program these will each use one memory space in the program.



The Combination of Commands is Incorrect

If you are programming stitches or letters and try to insert any of the functions STOP, FIX or Thread Cut into a stitch program in an order that is not allowed, this message will appear. Close the pop-up message with OK.

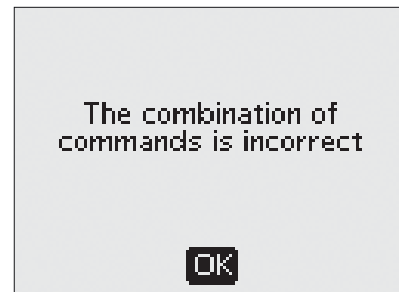

Commands Removed from Program (670/690Q)

If you try to insert a previously saved program into a new one or if you are using the mirroring end to end function (670/690Q) on the whole program, the result may be that the commands are put in an order that is not allowed. To avoid this, the commands will be removed from the program. Close the pop-up message with OK.

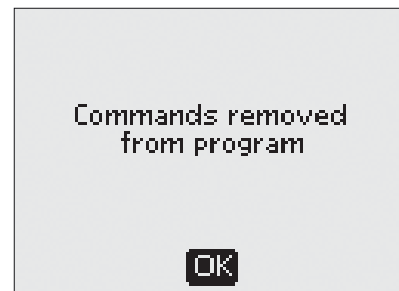

Bobbin Thread Low (670/690Q)

Your machine stops when the bobbin is almost empty. Replace the empty bobbin with a full one and close the pop-up message with OK.

Note: Continue sewing without closing the pop-up message if you want all thread on the bobbin to run out.

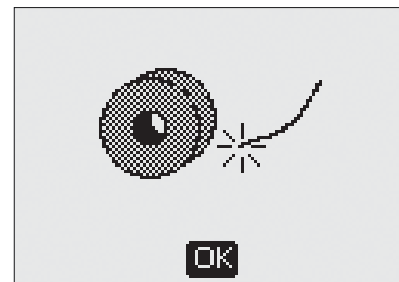

Remove Thread from Under Stitch Plate And In Bobbin Area (670/690Q)

When this pop-up message appears clean thread and lint from the area under the stitch plate to allow the Automatic Thread Cutter to cut properly. Close the pop-up message with OK.



TAKING CARE OF YOUR MACHINE



CLEANING THE MACHINE

To keep your sewing machine operating well, clean it often.
No lubrication (oiling) is needed.

Wipe the exterior surfaces of your sewing machine with a soft cloth to remove any dust or lint built up.

 Press the ON/OFF switch to OFF.

Clean the Bobbin Area

Remove the presser foot and slide off the bobbin cover. Lower the feed teeth. Place the screwdriver under the stitchplate as shown on the picture and gently turn the screwdriver to pop off the stitch plate. Clean the feed teeth with the brush.

Cleaning Under the Bobbin Area

After sewing several projects or any time you notice an accumulation of lint in the bobbin case area, the area under the bobbin case must be cleaned.

Remove the bobbin case holder (1) covering the front part of the bobbin case. Remove the bobbin case (2) by lifting it up. Clean with the brush. A small vacuum attachment works well to remove dust and lint built up.

 On model 670/690Q: Use caution when cleaning around the thread cut knife (A).

Put the bobbin case and the bobbin case holder back in place.

Note: Do not blow air into the bobbin case area. The dust and lint will be blown into your machine.

Replacing the Stitch Plate

With feed teeth lowered, place the stitch plate so that it fits into the notch at the back. Press the stitch plate down until it clicks into place. Slide on bobbin cover.

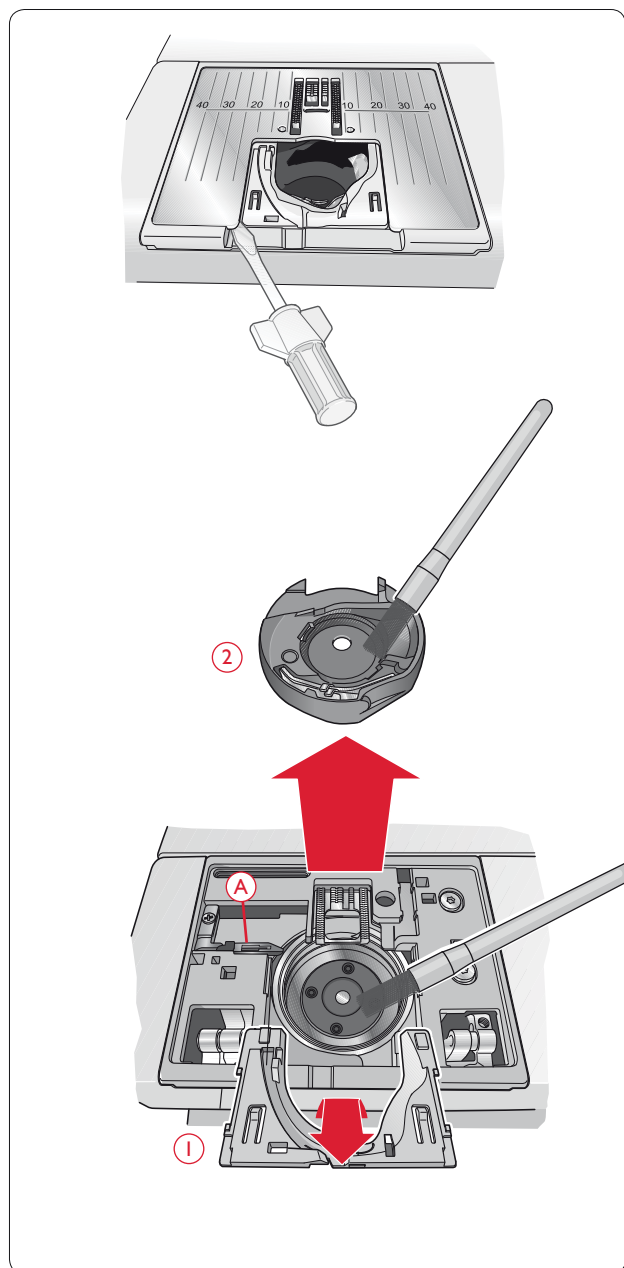

TROUBLESHOOTING

Any Time You Experience a Problem when Sewing:

- Select correct type and weight of fabric in the Exclusive SEWING ADVISOR™ feature.
- Insert needle size and type as recommended on the GraphicDisplay/TouchScreen.
- Rethread the top and bobbin threads.
- Use different spool pin positions (vertical or horizontal).
- Use thread nets (optional accessory, part number 4123977-01) and quality thread. We recommend the same sewing thread on top and bobbin for general sewing. For decorative sewing we recommend rayon thread on top and bobbin thread in the bobbin.

If You Experience Problems when Using the Sensor One-Step Buttonhole Foot:

- Make sure the white area on the side of the wheel is lined up with the white marking line on the foot.
- Check to insure that the cord to the Sensor One-Step Buttonhole Foot is properly plugged into the socket above the needle area.

Fabric Puckers?

- Select correct type and weight of fabric in the Exclusive SEWING ADVISOR™ feature.
- Use stabilizer.
- Check needle, it could be damaged.
- Insert needle size and type as recommended on the GraphicDisplay/TouchScreen.
- Rethread top and bobbin threads.
- Change thread type to match fabric and sewing technique.
- Use quality thread.
- Shorten stitch length.
- Check your thread tension.

Skipped Stitches?

- Check needle - it could be damaged.
- Change needle to recommended size and type.
- Be sure the needle is inserted correctly all the way into the clamp.
- Rethread top and bobbin threads.
- Use recommended presser foot.
- Turn machine off and on to reset.
- Consult your authorized HUSQVARNA VIKING® dealer for service.

Needle Breaks?

- Use care not to pull fabric when sewing.
- Insert needle size and type as recommended on the GraphicDisplay/TouchScreen.
- Insert needle correctly as described on page 15.

Poor Tension?

- Select correct type and weight of fabric in the Exclusive SEWING ADVISOR™ feature.
- Rethread top and bobbin - use quality thread.
- Insert needle size and type as recommended on the GraphicDisplay/TouchScreen.
- Follow recommendations for thread tension (650).
- Follow recommendations for stabilizer.

Upper Thread Breaks?

- Does thread feed smoothly/not catching?
- Use thread nets (optional accessory, part number 4123977-01) and quality thread. For special threads such as metallic etc. please consult the Accessory User's Guide (www.husqvarnaviking.com) for special needle recommendations.
- Rethread top and bobbin threads - check for correct threading. When using rayon thread on top, you should use bobbin thread in the bobbin, not regular sewing thread.
- Try different spool pin positions (horizontal or vertical).
- If stitch plate hole is damaged, replace stitch plate.
- Is the correct spool cap used in front of the thread?

Fabric Does Not Move?

- Check to make sure feed teeth are up.
- Increase stitch length.

Bobbin Thread Breaks?

- Replace the bobbin in the machine, check correct threading.
- Wind a new bobbin.
- If stitch plate hole is damaged - replace stitch plate.
- Clean bobbin area.

Bobbin Winds Irregularly?

- Check threading for bobbin winding.

Wrong Stitch, Irregular or Narrow Stitches?

- Turn machine off and on to reset.
- Change needle, rethread top and bobbin threads.
- Use stabilizer.

Machine Sews Slowly?

- Check speed.
- Remove stitch plate and brush lint from bobbin and teeth area.
- Check the foot control.
- Have your sewing machine serviced at your authorized HUSQVARNA VIKING® dealer.

Machine Will Not Sew?

- Put bobbin winder spindle to the left into sewing position.
- Check plugs are securely plugged all the way into the machine.
- Check wall plug and power to wall plug.
- Check foot control connection.

The Sewing Machine Functions do Not Respond to Touch?

- The sockets and functions on the machine can be sensitive to static electricity. If the functions do not respond to touch, turn the machine off and then on again. If the problem persists, contact your authorized HUSQVARNA VIKING® dealer.

Icons on the Screen are Not Activated when Touched? (670/690Q)

- Calibrate the screen. Calibration is found in the SET-Menu.

Have your Sewing Machine Serviced Regularly by your Authorized HUSQVARNA VIKING® Dealer!

If you have followed this trouble shooting information and still have sewing problems, take the sewing machine to your authorized HUSQVARNA VIKING® dealer. If there is a specific problem, it is a great help to test sew with your thread on a scrap of your sewing fabric and bring it to your authorized HUSQVARNA VIKING® dealer. A sewing sample will often give much better information than words.

Non-Original Parts and Accessories

The warranty does not cover any defect or damage caused by use of non-original accessories or parts.





This software works thanks to the open source component FreeRTOS (Copyright (C) 2011 Real Time Engineers Ltd.). You can receive a complete machine-readable copy of the source code by sending a written request to:

VSM Group AB
SE-561 84 Huskvarna
Sweden

This offer is valid for three years after the product was first purchased.

Intellectual property

Patents protecting this product are listed on a label positioned underneath the sewing machine.

VIKING, KEEPING THE WORLD SEWING & Design, OPAL, EXCLUSIVE SENSOR SYSTEM and SEWING ADVISOR are trademarks of KSIN Luxembourg II, S.ar.l.

HUSQVARNA and the “crowned H-mark” are trademarks of Husqvarna AB. All trademarks are used under license by VSM Group AB.

We reserve the right to change the machine equipment and the assortment of accessories without prior notice, or make modifications to the performance or design.

Such modifications, however, will always be to the benefit of the user and the product.



Please note that on disposal, this product must be safely recycled in accordance with relevant National legislation relating to electrical/electronic products. Do not dispose of electrical appliances as unsorted municipal waste, use separate collection facilities. Contact your local government for information regarding the collection systems available. When replacing old appliances with new ones, the retailer may be legally obligated to take back your old appliance for disposal free of charge.

If electrical appliances are disposed of in landfills or dumps, hazardous substances can leak into the groundwater and get into the food chain, damaging your health and well-being.

CE - Authorised Representative

VSM Group AB, **SVP Worldwide**
Drottningatan 2, SE-56184, Huskvarna, SWEDEN

